

LC-R061R3P*1

DIMENSIONS (MM)

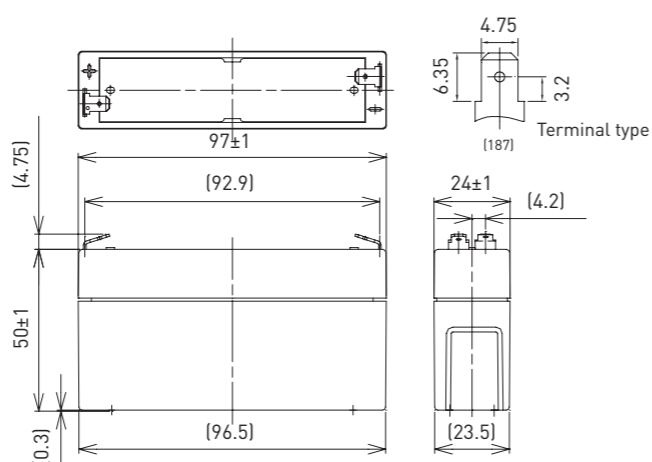

FOR MAIN AND STANDBY POWER SUPPLIES.
EXPECTED TRICKLE DESIGN LIFE: 6 - 9 YEARS AT 20°C
ACCORDING TO EUROBAT.



Battery case resin: standard (UL94 HB)

Contents indicated (including the recycle marking, etc.) are subject to change without notice.

SPECIFICATIONS

Name	LC-R061R3P*1	
Nominal voltage	6V	
Nominal capacity (20 hour rate)	1.3Ah	
Dimensions	Length	97mm
	Width	24mm
	Height	55mm
Approx. mass	0.25kg	
Terminal	Faston 187	
Capacity (25°C)	20 hour rate	1.3Ah
	10 hour rate	1.2Ah
	3 hour rate	1.1Ah
	1 hour rate	0.9Ah
Impedance	Fully charged battery (25°C)	50mΩ
	40°C	102%
Temperature dependency of capacity (20 hour rate)	25°C	100%
	0°C	85%
	-15°C	65%
Self-discharge (25°C)	After 3 month	91%
	After 6 month	82%
	After 12 month	64%

DURATION OF DISCHARGE VS. DISCHARGE CURRENT

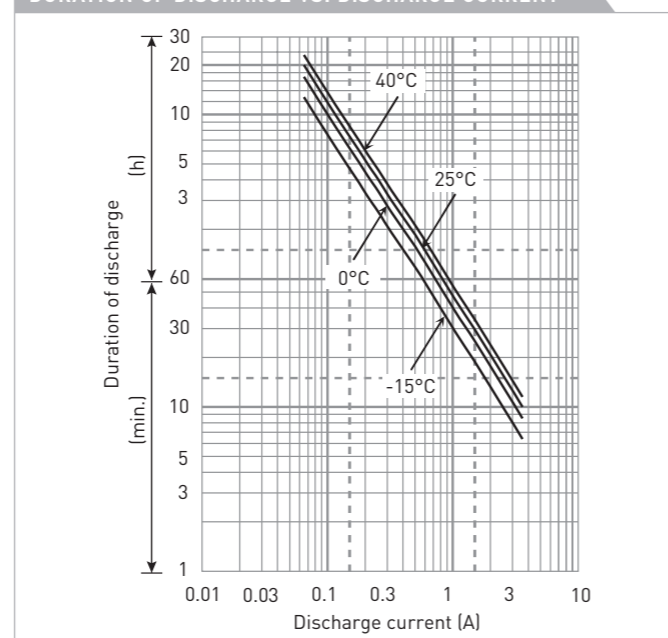

WATT TABLE (25°C)

Cut-off	(Wattage/battery)															
	3min.	5min.	10min.	15min.	20min.	30min.	45min.	1h	1.5h	2h	3h	4h	5h	6h	10h	20h
4.80V	39.1	30.8	20.1	15.4	12.9	9.61	6.78	5.42	3.73	2.89	2.15	1.65	1.36	1.10	0.726	0.393
4.95V	36.2	28.9	19.7	15.3	12.7	9.51	6.74	5.37	3.66	2.86	2.14	1.64	1.35	1.09	0.723	0.392
5.10V	33.4	27.1	19.2	15.0	12.5	9.40	6.68	5.32	3.58	2.79	2.12	1.63	1.34	1.08	0.715	0.391
5.25V	29.7	24.3	17.8	13.9	11.8	9.19	6.57	5.21	3.51	2.69	2.08	1.62	1.33	1.07	0.712	0.390
5.40V	25.1	21.4	15.9	13.0	11.5	8.87	6.47	5.10	3.41	2.57	2.04	1.60	1.30	1.05	0.704	0.388

AMPERE TABLE (25°C)

Cut-off	(Ampere/battery)															
	3min.	5min.	10min.	15min.	20min.	30min.	45min.	1h	1.5h	2h	3h	4h	5h	6h	10h	20h
4.80V	7.02	5.53	3.59	2.67	2.22	1.64	1.16	0.921	0.634	0.484	0.363	0.276	0.228	0.185	0.122	0.066
4.95V	6.52	5.18	3.52	2.65	2.18	1.63	1.15	0.912	0.621	0.480	0.361	0.274	0.226	0.184	0.121	0.065
5.10V	6.01	4.86	3.43	2.60	2.15	1.61	1.14	0.903	0.609	0.468	0.358	0.273	0.224	0.183	0.120	0.065
5.25V	5.34	4.35	3.18	2.42	2.04	1.57	1.12	0.885	0.596	0.451	0.352	0.272	0.222	0.182	0.119	0.065
5.40V	4.51	3.85	2.83	2.26	1.99	1.52	1.10	0.867	0.578	0.433	0.343	0.271	0.217	0.181	0.117	0.063

All mentioned values are average values

LC-R061R3P*1

CHARGING METHOD (25°C)

Cycle use Control voltage: 7.25V - 7.45V
Initial current: 0.52A or smaller

CUT-OFF VOLTAGE

Discharge current	0.065A - 0.26A	0.26A - 0.65A	0.65A - 1.30A	1.30A - 2.60A	2.60A - 3.90A
Cut-off voltage	5.25V	5.10V	4.95V	4.65V	4.35V

CYCLE LIFE VS. DEPTH OF DISCHARGE (ACC. IEC 61056)

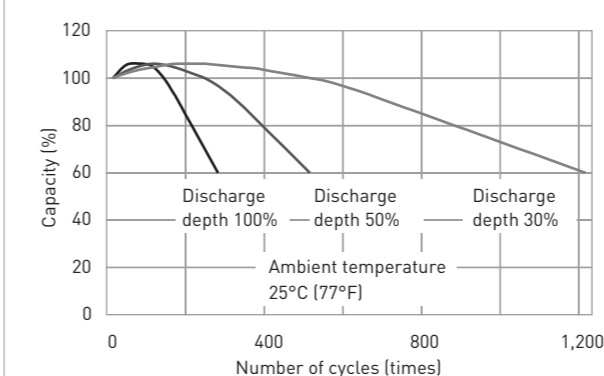

RESIDUAL CAPACITY TEST RESULT

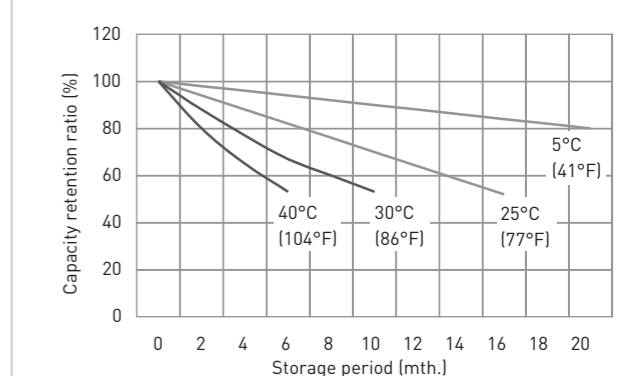

CONSTANT-VOLTAGE CONSTANT-CURRENT CHARGE CHARACTERISTICS FOR CYCLE USE

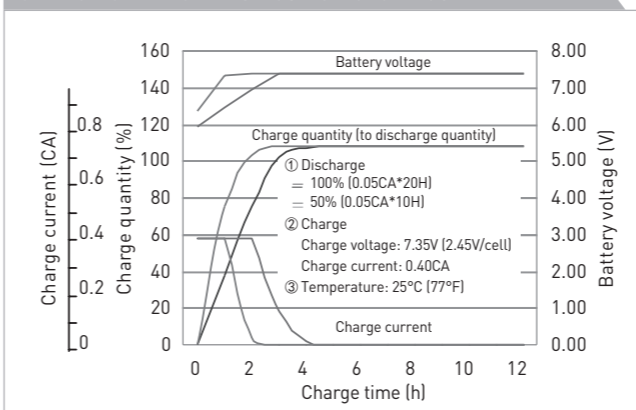

DISCHARGE CAPACITY BY TEMPERATURE AND BY DISCHARGE CURRENT

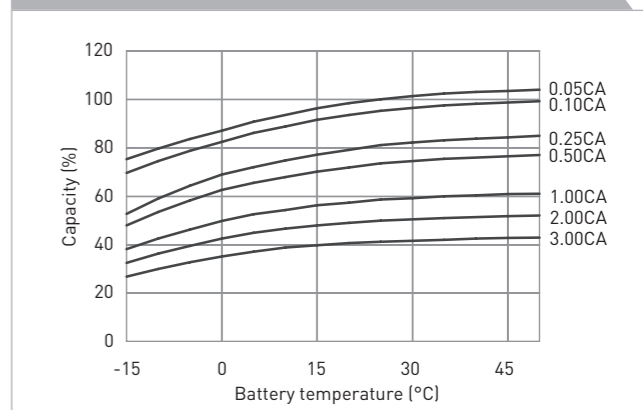

DISCHARGE CHARACTERISTICS

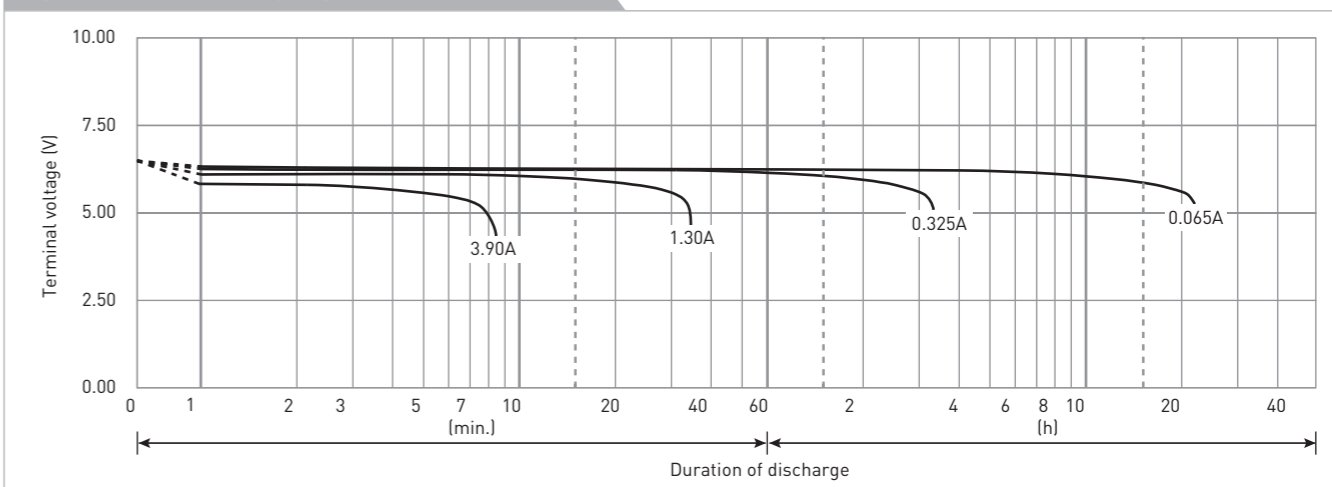

The data in this document are for descriptive purposes only and are not intended to make or imply any guarantee or warranty. Regarding handling and safety please consult our VRLA technical handbook chapter 1.

LC-R063R4P*1

DIMENSIONS (MM)



FOR MAIN AND STANDBY POWER SUPPLIES.
EXPECTED TRICKLE DESIGN LIFE: 6 - 9 YEARS AT 20°C
ACCORDING TO EUROBAT.

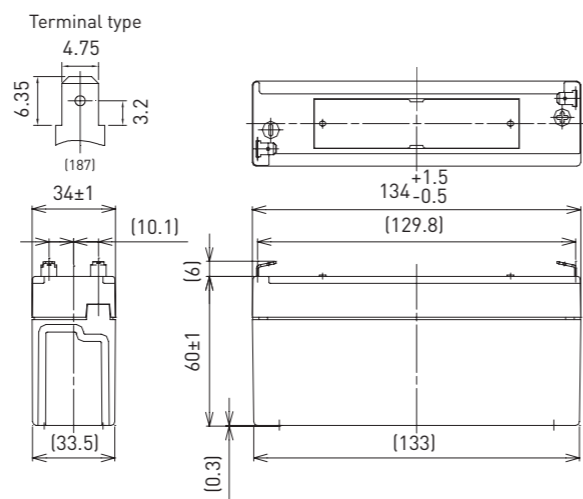

Battery case resin: standard (UL94 HB)

Contents indicated (including the recycle marking, etc.) are subject to change without notice.

SPECIFICATIONS

Name	LC-R063R4P*1	
Nominal voltage	6V	
Nominal capacity (20 hour rate)	3.4Ah	
Dimensions	Length	134mm
	Width	34mm
	Height	66mm
Approx. mass	0.60kg	
Terminal	Faston 187	
Capacity (25°C)	20 hour rate	3.4Ah
	10 hour rate	3.1Ah
	3 hour rate	2.8Ah
	1 hour rate	2.3Ah
Impedance	Fully charged battery (25°C)	30mΩ
	Temperature dependency of capacity (20 hour rate)	
	40°C	102%
	25°C	100%
	0°C	85%
	-15°C	65%
Self-discharge (25°C)	After 3 month	91%
	After 6 month	82%
	After 12 month	64%

DURATION OF DISCHARGE VS. DISCHARGE CURRENT

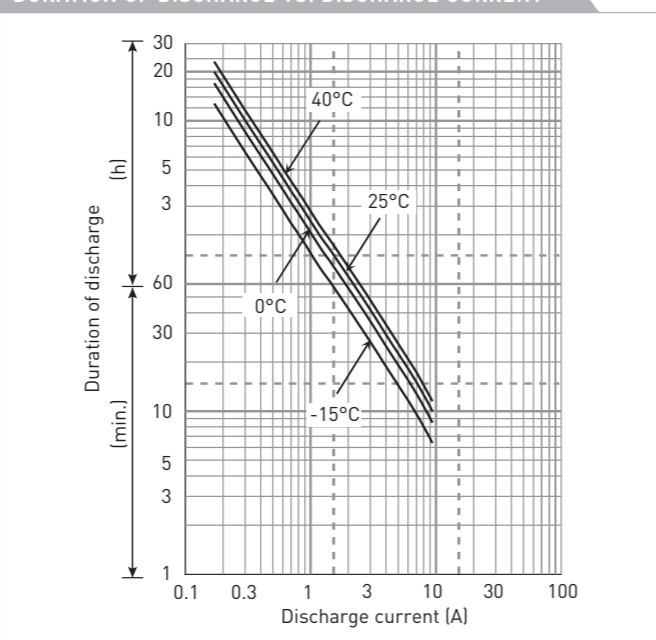

WATT TABLE (25°C)

Cut-off	3min.	5min.	10min.	15min.	20min.	30min.	45min.	1h	1.5h	2h	3h	4h	5h	6h	10h	20h
4.80V	102	80.6	52.6	40.2	33.7	25.1	17.7	14.2	9.76	7.55	5.62	4.32	3.56	2.86	1.90	1.03
4.95V	94.8	75.6	51.6	39.9	33.1	24.9	17.6	14.1	9.56	7.49	5.59	4.29	3.54	2.85	1.89	1.03
5.10V	87.4	70.8	50.2	39.1	32.6	24.6	17.5	13.9	9.37	7.30	5.54	4.26	3.51	2.83	1.87	1.02
5.25V	77.7	63.4	46.5	36.4	30.9	24.0	17.2	13.6	9.17	7.04	5.45	4.23	3.48	2.80	1.86	1.02
5.40V	65.6	56.1	41.5	33.9	30.1	23.2	16.9	13.4	8.92	6.71	5.34	4.18	3.39	2.75	1.84	1.01

AMPERE TABLE (25°C)

Cut-off	3min.	5min.	10min.	15min.	20min.	30min.	45min.	1h	1.5h	2h	3h	4h	5h	6h	10h	20h
4.80V	18.4	14.4	9.40	6.99	5.81	4.30	3.02	2.41	1.66	1.26	0.949	0.722	0.595	0.484	0.318	0.171
4.95V	17.0	13.6	9.21	6.94	5.71	4.25	3.00	2.39	1.62	1.24	0.945	0.718	0.590	0.482	0.316	0.171
5.10V	15.7	12.7	8.97	6.80	5.62	4.20	2.97	2.36	1.59	1.22	0.935	0.713	0.586	0.478	0.313	0.170
5.25V	14.0	11.4	8.31	6.33	5.34	4.11	2.93	2.31	1.56	1.18	0.921	0.710	0.581	0.475	0.312	0.170
5.40V	11.8	10.1	7.41	5.90	5.19	3.97	2.88	2.27	1.51	1.13	0.897	0.708	0.567	0.472	0.307	0.165

All mentioned values are average values

LC-R063R4P*1

CHARGING METHOD (25°C)

Cycle use Control voltage: 7.25V - 7.45V
Initial current: 1.36A or smaller

CUT-OFF VOLTAGE

Discharge current	0.17A - 0.68A	0.68A - 1.7A	1.7A - 3.4A	3.4A - 6.8A	6.8A - 10.2A
Cut-off voltage	5.25V	5.10V	4.95V	4.65V	4.35V

CYCLE LIFE VS. DEPTH OF DISCHARGE (ACC. IEC 61056)

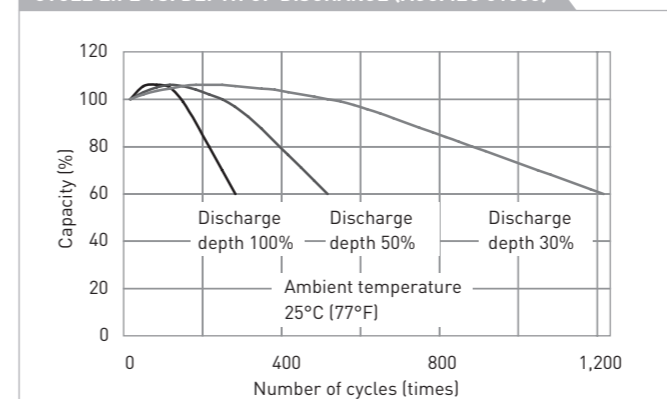

RESIDUAL CAPACITY TEST RESULT

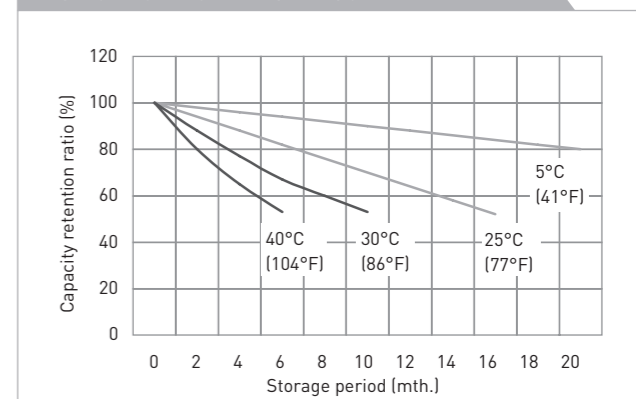

CONSTANT-VOLTAGE CONSTANT-CURRENT CHARGE CHARACTERISTICS FOR CYCLE USE

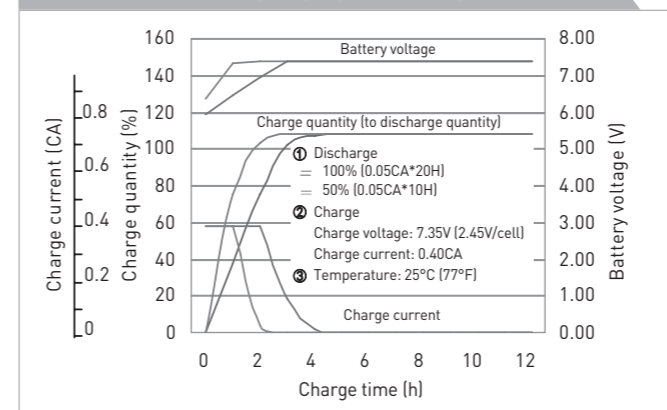

DISCHARGE CAPACITY BY TEMPERATURE AND BY DISCHARGE CURRENT

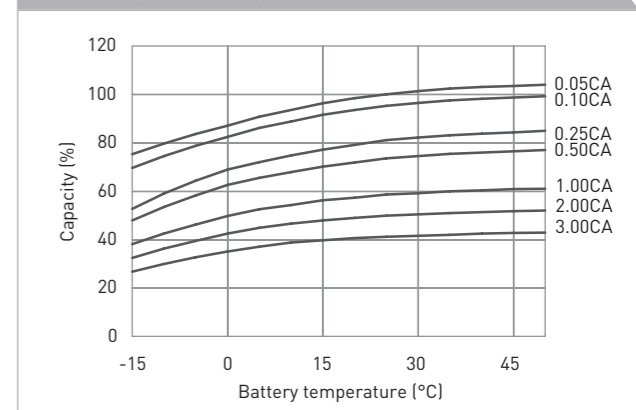

DISCHARGE CHARACTERISTICS

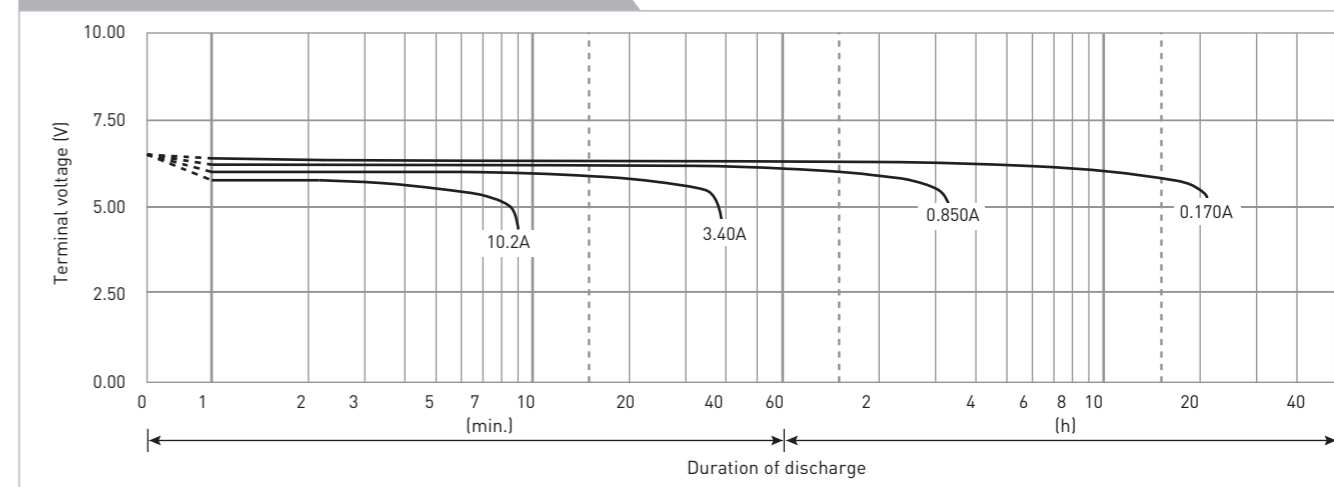

The data in this document are for descriptive purposes only and are not intended to make or imply any guarantee or warranty. Regarding handling and safety please consult our VRLA technical handbook chapter 1.

LC-R064R5P*1

DIMENSIONS (MM)



Contents indicated (including the recycle marking, etc.) are subject to change without notice.

FOR MAIN AND STANDBY POWER SUPPLIES.
EXPECTED TRICKLE DESIGN LIFE: 6 - 9 YEARS AT 20°C
ACCORDING TO EUROBAT.

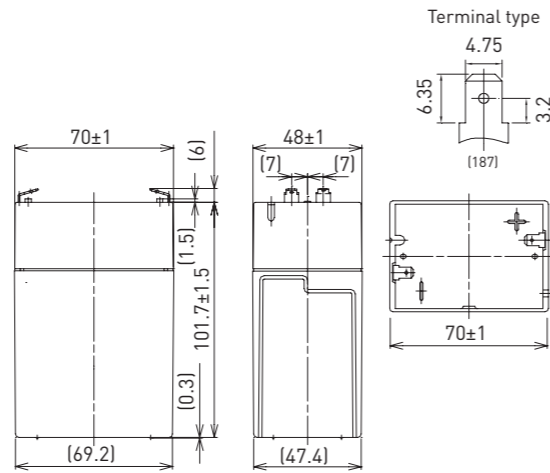

Battery case resin: standard (UL94 HB)

SPECIFICATIONS

Name	LC-R064R5P*1	
Nominal voltage	6V	
Nominal capacity (20 hour rate)	4.5Ah	
Dimensions	Length	70mm
	Width	48mm
	Height	108mm
Approx. mass	0.70kg	
Terminal	Faston 187	
Capacity (25°C)	20 hour rate	4.5Ah
	10 hour rate	4.1Ah
	3 hour rate	3.6Ah
	1 hour rate	3.1Ah
Impedance	Fully charged battery (25°C)	20mΩ
	40°C	102%
Temperature dependency of capacity (20 hour rate)	25°C	100%
	0°C	85%
	-15°C	65%
	After 3 month	91%
Self-discharge (25°C)	After 6 month	82%
	After 12 month	64%

DURATION OF DISCHARGE VS. DISCHARGE CURRENT

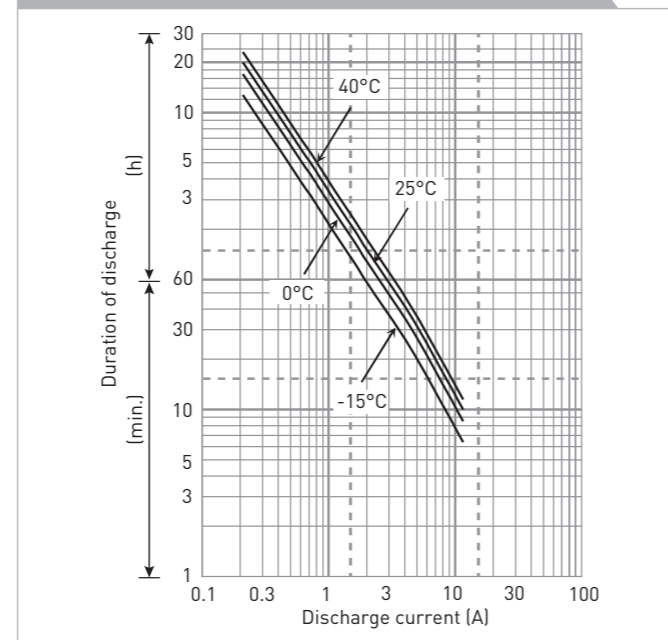

WATT TABLE (25°C)

Cut-off	(Wattage/battery)															
	3min.	5min.	10min.	15min.	20min.	30min.	45min.	1h	1.5h	2h	3h	4h	5h	6h	10h	20h
4.80V	135	107	69.7	53.2	44.6	33.3	23.5	18.8	12.9	9.99	7.44	5.71	4.72	3.79	2.51	1.36
4.95V	125	100	68.3	52.8	43.9	32.9	23.3	18.6	12.7	9.92	7.40	5.68	4.68	3.78	2.50	1.36
5.10V	116	93.7	66.5	51.8	43.1	32.5	23.1	18.4	12.4	9.66	7.33	5.64	4.64	3.75	2.48	1.35
5.25V	103	84.0	61.6	48.2	41.0	31.8	22.7	18.0	12.1	9.32	7.21	5.60	4.60	3.70	2.46	1.35
5.40V	86.9	74.2	55.0	44.9	39.9	30.7	22.4	17.7	11.8	8.88	7.07	5.53	4.49	3.64	2.44	1.34

AMPERE TABLE (25°C)

Cut-off	(Ampere/battery)															
	3min.	5min.	10min.	15min.	20min.	30min.	45min.	1h	1.5h	2h	3h	4h	5h	6h	10h	20h
4.80V	24.3	19.1	12.4	9.25	7.69	5.69	4.00	3.19	2.19	1.69	1.25	0.956	0.788	0.633	0.419	0.227
4.95V	22.6	17.9	12.2	9.19	7.56	5.63	3.98	3.16	2.14	1.68	1.24	0.950	0.781	0.630	0.417	0.226
5.10V	20.8	16.8	11.9	9.00	7.44	5.56	3.94	3.13	2.10	1.63	1.23	0.944	0.775	0.625	0.413	0.226
5.25V	18.5	15.1	11.0	8.38	7.06	5.44	3.88	3.06	2.06	1.58	1.21	0.938	0.769	0.618	0.411	0.225
5.40V	15.6	13.3	9.81	7.81	6.88	5.25	3.81	3.00	2.00	1.50	1.19	0.925	0.750	0.608	0.406	0.224

All mentioned values are average values

LC-R064R5P*1

CHARGING METHOD (25°C)

Cycle use Control voltage: 7.25V - 7.45V
Initial current: 1.80A or smaller

CUT-OFF VOLTAGE

Discharge current	0.225A - 0.900A	0.900A - 2.25A	2.25A - 4.50A	4.50A - 9.00A	9.00A - 13.5A
Cut-off voltage	5.25V	5.10V	4.95V	4.65V	4.35V

CYCLE LIFE VS. DEPTH OF DISCHARGE (ACC. IEC 61056)

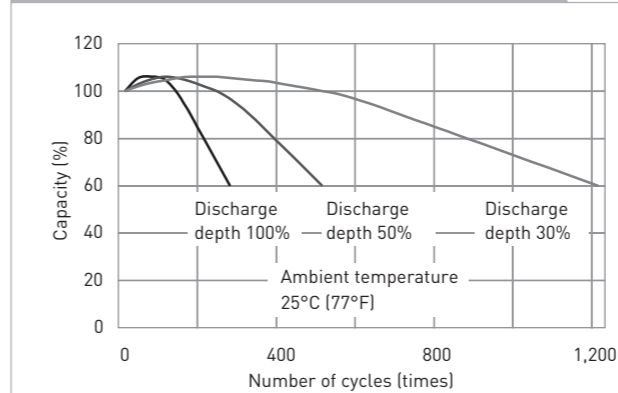

RESIDUAL CAPACITY TEST RESULT

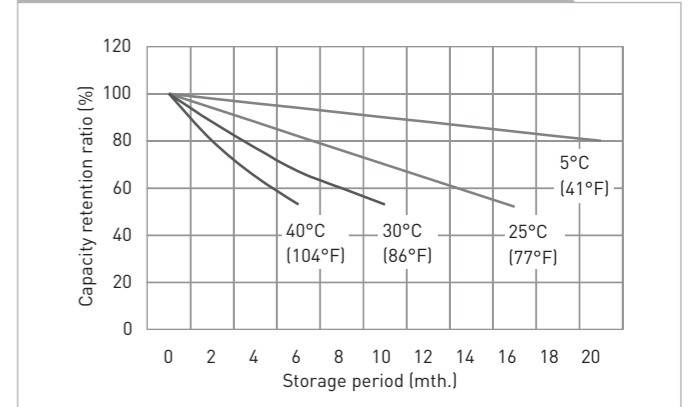

CONSTANT-VOLTAGE CONSTANT-CURRENT CHARGE CHARACTERISTICS FOR CYCLE USE

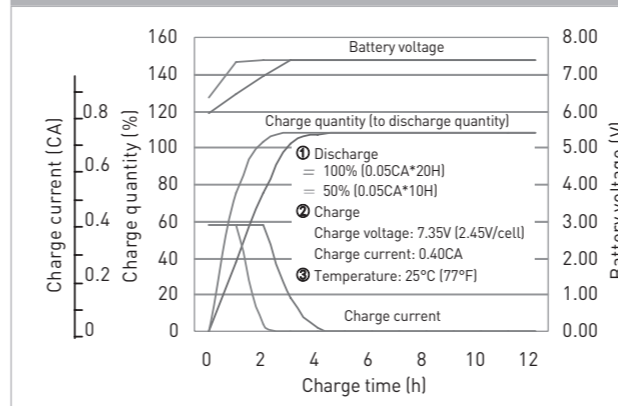

DISCHARGE CAPACITY BY TEMPERATURE AND BY DISCHARGE CURRENT

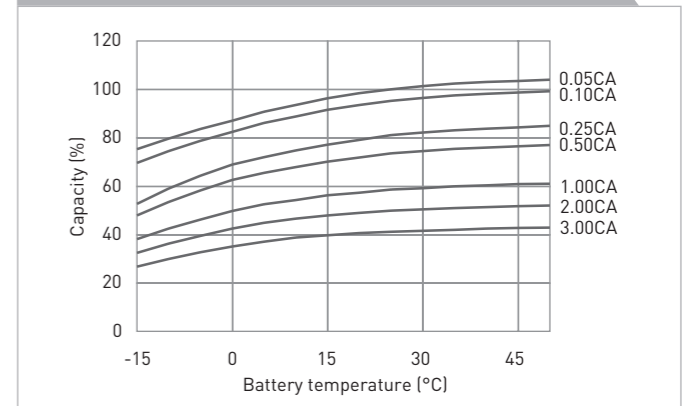

DISCHARGE CHARACTERISTICS

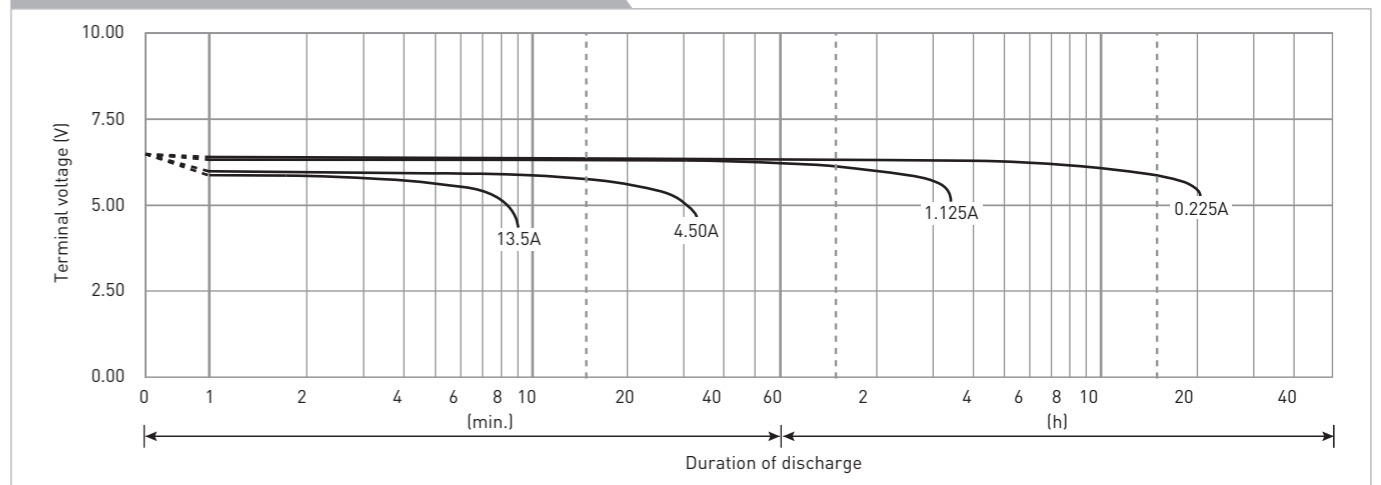

The data in this document are for descriptive purposes only and are not intended to make or imply any guarantee or warranty. Regarding handling and safety please consult our VRLA technical handbook chapter 1.

LC-R067R2P*1

DIMENSIONS (MM)



FOR MAIN AND STANDBY POWER SUPPLIES.
EXPECTED TRICKLE DESIGN LIFE: 6 - 9 YEARS AT 20°C
ACCORDING TO EUROBAT.

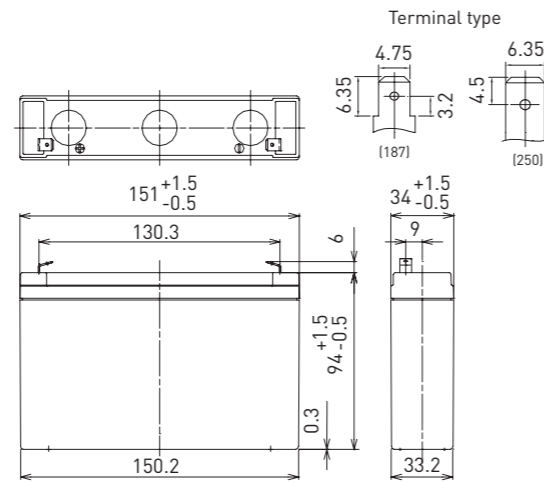

Battery case resin: standard (UL94 HB)

Contents indicated (including the recycle marking, etc.) are subject to change without notice.

SPECIFICATIONS

Name	LC-R067R2P*1	
Nominal voltage	6V	
Nominal capacity (20 hour rate)	7.2Ah	
Dimensions	Length	151mm
	Width	34mm
	Height	100mm
Approx. mass	1.30kg	
Terminal	Faston 187/250	
Capacity (25°C)	20 hour rate	7.2Ah
	10 hour rate	6.6Ah
	3 hour rate	5.8Ah
	1 hour rate	4.9Ah
Impedance	Fully charged battery (25°C)	11mΩ
	40°C	102%
Temperature dependency of capacity (20 hour rate)	25°C	100%
	0°C	85%
	-15°C	65%
Self-discharge (25°C)	After 3 month	91%
	After 6 month	82%
	After 12 month	64%

DURATION OF DISCHARGE VS. DISCHARGE CURRENT

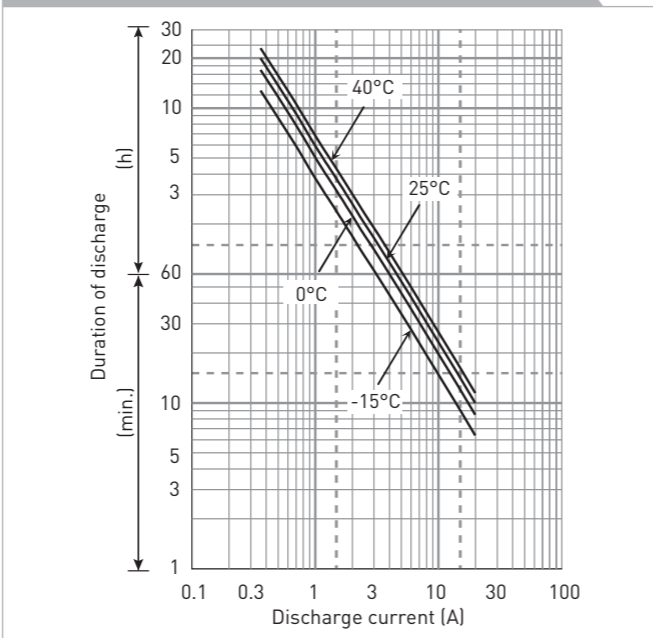

WATT TABLE (25°C)

Cut-off	[Wattage/battery]															
	3min.	5min.	10min.	15min.	20min.	30min.	45min.	1h	1.5h	2h	3h	4h	5h	6h	10h	20h
4.80V	215	167	110	83.5	67.1	49.2	36.0	28.2	22.3	17.3	12.3	9.60	7.69	6.40	4.19	2.30
4.95V	202	143	93.5	79.5	64.8	48.2	35.8	27.6	21.9	17.2	12.1	9.53	7.63	6.27	4.18	2.29
5.10V	189	136	91.0	75.5	63.0	47.2	34.3	26.8	20.7	16.3	11.8	9.33	7.32	6.11	4.00	2.21
5.25V	172	124	86.8	72.2	60.2	45.4	33.4	26.2	19.9	15.8	11.5	9.15	7.27	6.05	3.98	2.14
5.40V	154	112	82.0	69.1	57.7	43.6	31.3	24.2	18.6	14.0	10.7	8.46	6.67	5.60	3.71	2.07

AMPERE TABLE (25°C)

Cut-off	[Ampere/battery]															
	3min.	5min.	10min.	15min.	20min.	30min.	45min.	1h	1.5h	2h	3h	4h	5h	6h	10h	20h
4.80V	38.9	30.6	19.9	14.8	12.3	9.10	6.40	5.10	3.50	2.70	2.00	1.53	1.26	1.02	0.670	0.363
4.95V	36.1	28.7	19.5	14.7	12.1	9.00	6.36	5.05	3.43	2.68	1.99	1.52	1.25	1.01	0.667	0.362
5.10V	34.2	26.9	19.0	14.4	11.9	8.90	6.30	5.00	3.36	2.61	1.97	1.51	1.24	1.00	0.660	0.361
5.25V	31.4	24.1	17.6	13.4	11.3	8.70	6.20	4.90	3.29	2.52	1.94	1.50	1.23	0.988	0.657	0.360
5.40V	29.0	22.3	15.7	12.5	11.0	8.40	6.10	4.80	3.20	2.40	1.90	1.48	1.20	0.972	0.650	0.358

All mentioned values are average values

LC-R067R2P*1

CHARGING METHOD (25°C)

Cycle use Control voltage: 7.25V - 7.45V
Initial current: 2.88A or smaller

CUT-OFF VOLTAGE

Discharge current	0.360A - 1.44A	1.44A - 3.60A	3.60A - 7.20A	7.20A - 14.4A	14.4A - 21.6A
Cut-off voltage	5.25V	5.10V	4.95V	4.65V	4.35V

CYCLE LIFE VS. DEPTH OF DISCHARGE (ACC. IEC 61056)

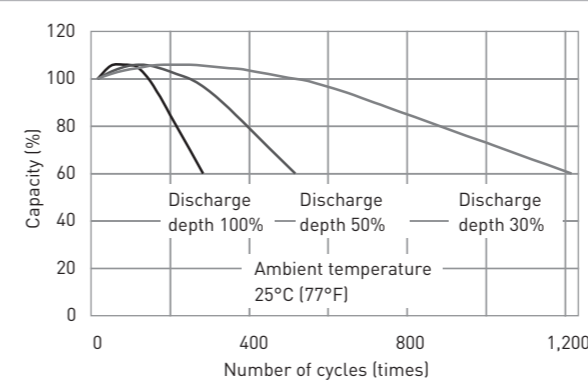

RESIDUAL CAPACITY TEST RESULT

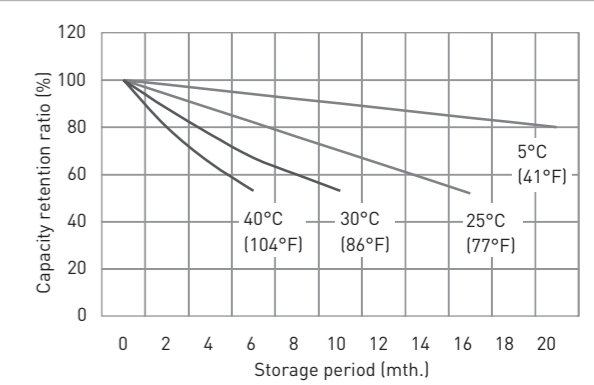

CONSTANT-VOLTAGE CONSTANT-CURRENT CHARGE CHARACTERISTICS FOR CYCLE USE

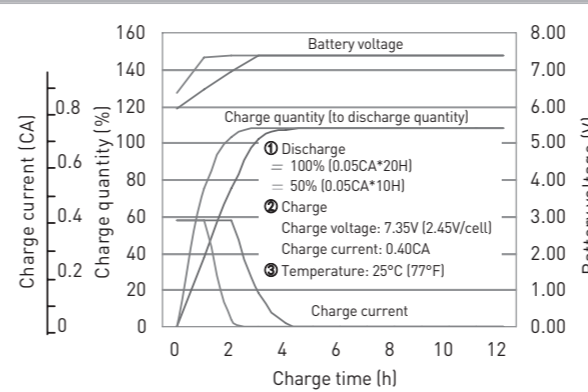

DISCHARGE CAPACITY BY TEMPERATURE AND BY DISCHARGE CURRENT

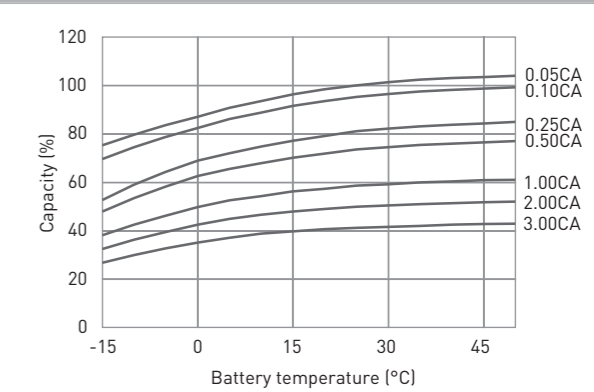

DISCHARGE CHARACTERISTICS

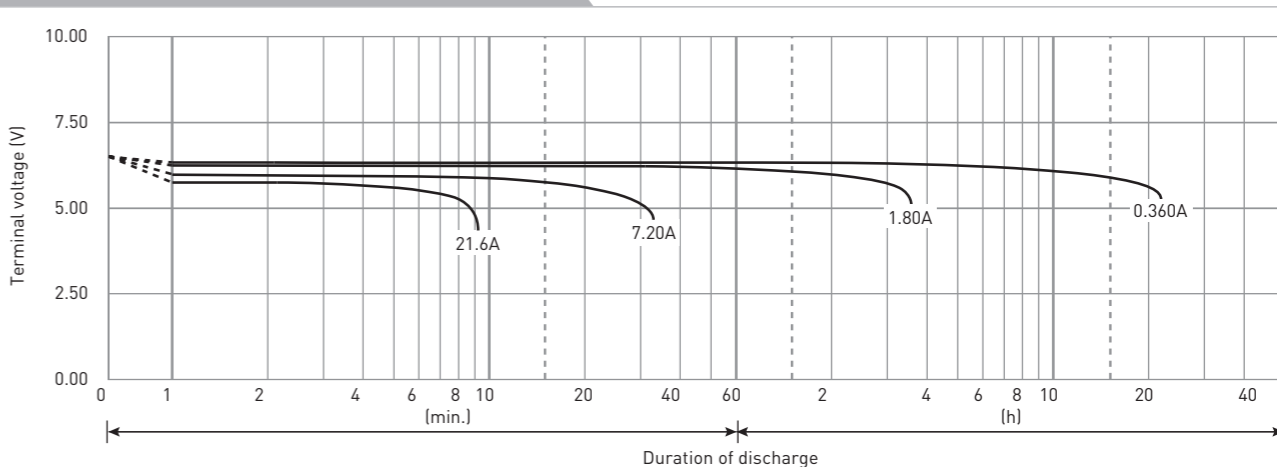

The data in this document are for descriptive purposes only and are not intended to make or imply any guarantee or warranty. Regarding handling and safety please consult our VRLA technical handbook chapter 1.

LC-R0612P*1

DIMENSIONS (MM)



FOR MAIN AND STANDBY POWER SUPPLIES.
EXPECTED TRICKLE DESIGN LIFE: 6 - 9 YEARS AT 20°C
ACCORDING TO EUROBAT.

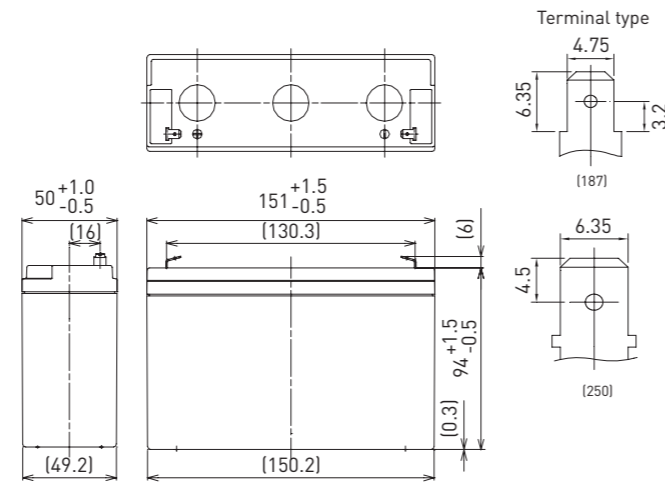

Contents indicated (including the recycle marking, etc.) are subject to change without notice.

Battery case resin: standard (UL94 HB)

SPECIFICATIONS

Name		LC-R0612P*1
Nominal voltage		6V
Nominal capacity (20 hour rate)		12.0Ah
Dimensions	Length	151mm
	Width	50mm
	Height	100mm
Approx. mass		1.95kg
Terminal		Faston 187/250
Capacity (25°C)	20 hour rate	12Ah
	10 hour rate	11Ah
	3 hour rate	9.3Ah
	1 hour rate	8.5Ah
Impedance		Fully charged battery (25°C) 9mΩ
Temperature dependency of capacity (20 hour rate)	40°C	102%
	25°C	100%
	0°C	85%
	-15°C	65%
Self-discharge (25°C)	After 3 month	91%
	After 6 month	82%
	After 12 month	64%

DURATION OF DISCHARGE VS. DISCHARGE CURRENT

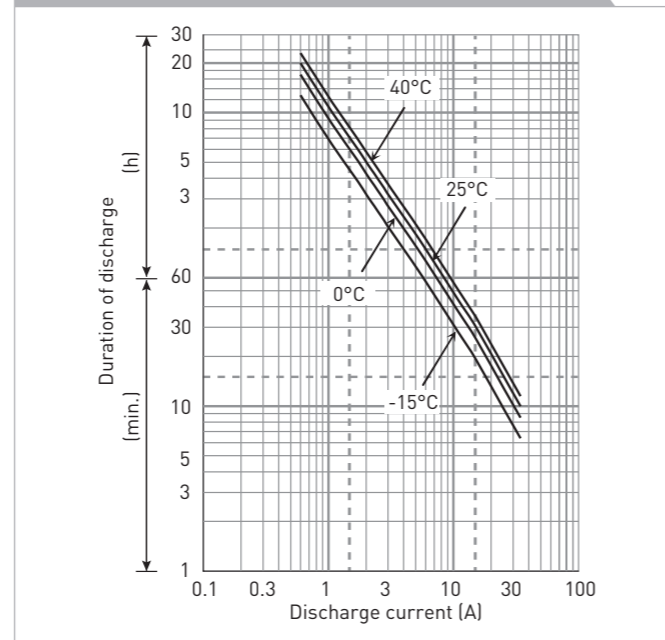

WATT TABLE (25°C)

Cut-off	(Wattage/battery)															
	3min.	5min.	10min.	15min.	20min.	30min.	45min.	1h	1.5h	2h	3h	4h	5h	6h	10h	20h
4.80V	340	279	192	149	124	91.3	68.7	52.4	35.1	27.2	19.0	14.4	12.0	10.9	6.66	3.61
4.95V	325	269	186	144	121	88.3	67.5	51.8	35.0	27.1	18.9	14.4	12.0	10.9	6.66	3.61
5.10V	304	253	181	141	118	87.2	66.9	51.2	34.5	26.9	18.7	14.4	12.0	10.8	6.60	3.61
5.25V	278	237	171	136	115	86.0	66.3	50.1	34.2	26.6	18.4	14.3	12.0	10.8	6.60	3.60
5.40V	247	217	161	131	113	83.1	61.6	48.9	33.1	26.0	18.1	14.2	11.9	10.7	6.54	3.59

AMPERE TABLE (25°C)

Cut-off	(Ampere/battery)															
	3min.	5min.	10min.	15min.	20min.	30min.	45min.	1h	1.5h	2h	3h	4h	5h	6h	10h	20h
4.80V	61.1	50.1	34.3	25.9	21.3	15.6	11.7	8.90	5.95	4.60	3.20	2.41	2.01	1.81	1.11	0.602
4.95V	58.4	48.2	33.3	25.0	20.8	15.1	11.5	8.80	5.92	4.58	3.18	2.41	2.01	1.81	1.11	0.602
5.10V	54.6	45.4	32.4	24.5	20.3	14.9	11.4	8.70	5.85	4.55	3.15	2.41	2.00	1.80	1.10	0.601
5.25V	50.0	42.6	30.6	23.6	19.9	14.7	11.3	8.50	5.80	4.50	3.10	2.40	2.00	1.80	1.10	0.600
5.40V	44.5	38.9	28.7	22.7	19.4	14.2	10.5	8.30	5.60	4.40	3.05	2.38	1.99	1.79	1.09	0.598

All mentioned values are average values

LC-R0612P*1

CHARGING METHOD (25°C)

Cycle use Control voltage: 7.25V - 7.45V
Initial current: 4.80A or smaller

CUT-OFF VOLTAGE

Discharge current	0.600A - 2.40A	2.40A - 6.00A	6.00A - 12.0A	12.0A - 24.0A	24.0A - 36.0A
Cut-off voltage	5.25V	5.10V	4.95V	4.65V	4.35V

CYCLE LIFE VS. DEPTH OF DISCHARGE (ACC. IEC 61056)

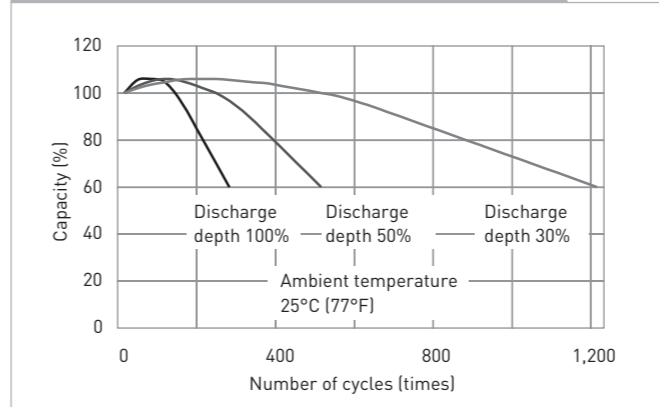

RESIDUAL CAPACITY TEST RESULT

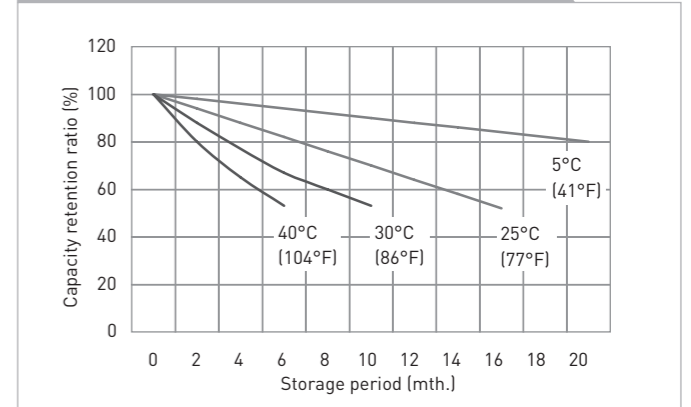

CONSTANT-VOLTAGE CONSTANT-CURRENT CHARGE CHARACTERISTICS FOR CYCLE USE

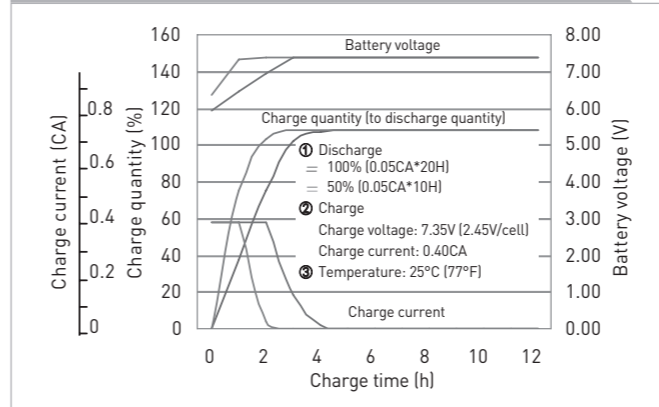

DISCHARGE CAPACITY BY TEMPERATURE AND BY DISCHARGE CURRENT

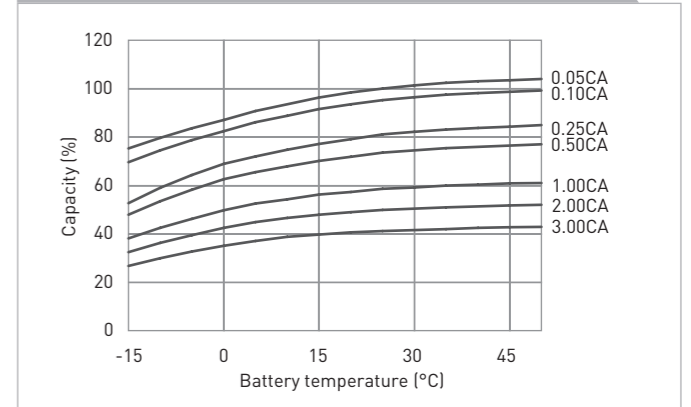

DISCHARGE CHARACTERISTICS

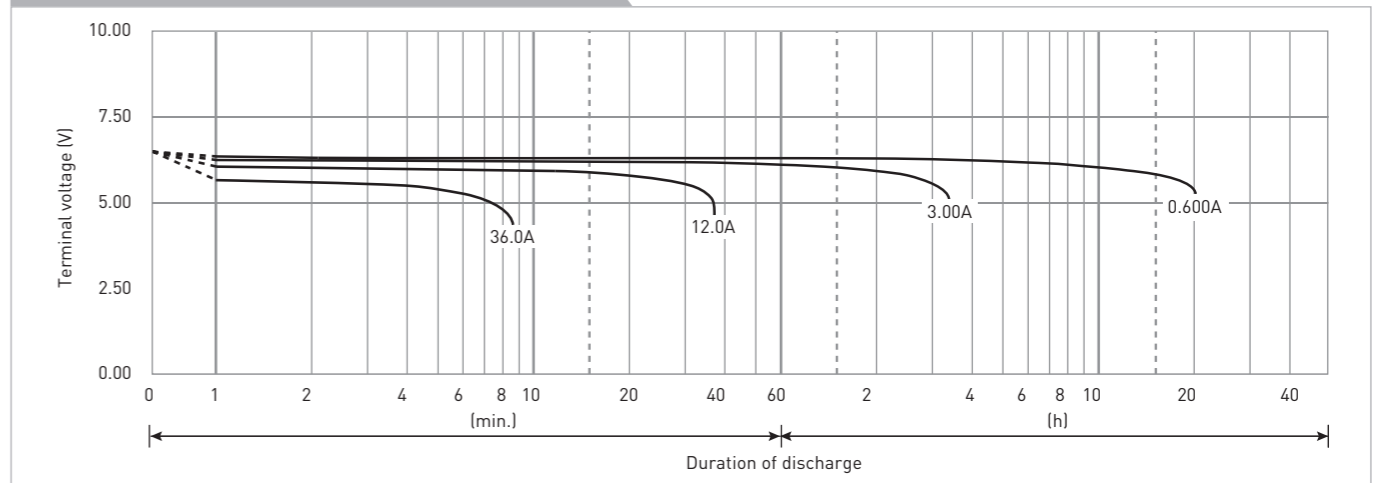

The data in this document are for descriptive purposes only and are not intended to make or imply any guarantee or warranty. Regarding handling and safety please consult our VRLA technical handbook chapter 1.

LC-R121R3P*1

DIMENSIONS (MM)



FOR MAIN AND STANDBY POWER SUPPLIES.
EXPECTED TRICKLE DESIGN LIFE: 6 - 9 YEARS AT 20°C
ACCORDING TO EUROBAT.



G196049

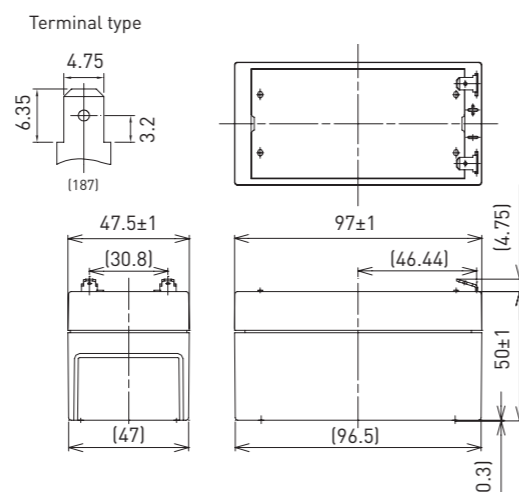

Contents indicated (including the recycle marking, etc.) are subject to change without notice.

Battery case resin: standard (UL94 HB)

SPECIFICATIONS

Name	LC-R121R3P*1	
Nominal voltage	6V	
Nominal capacity (20 hour rate)	1.3Ah	
Dimensions	Length	97mm
	Width	47.5mm
	Height	55mm
Approx. mass	0.55kg	
Terminal	Faston 187	
Capacity (25°C)	20 hour rate	1.3Ah
	10 hour rate	1.2Ah
	3 hour rate	1.1Ah
	1 hour rate	0.9Ah
Impedance	Fully charged battery (25°C)	90mΩ
	Temperature dependency of capacity (20 hour rate)	
	40°C	102%
	25°C	100%
	0°C	85%
	-15°C	65%
Self-discharge (25°C)	After 3 month	91%
	After 6 month	82%
	After 12 month	64%

DURATION OF DISCHARGE VS. DISCHARGE CURRENT

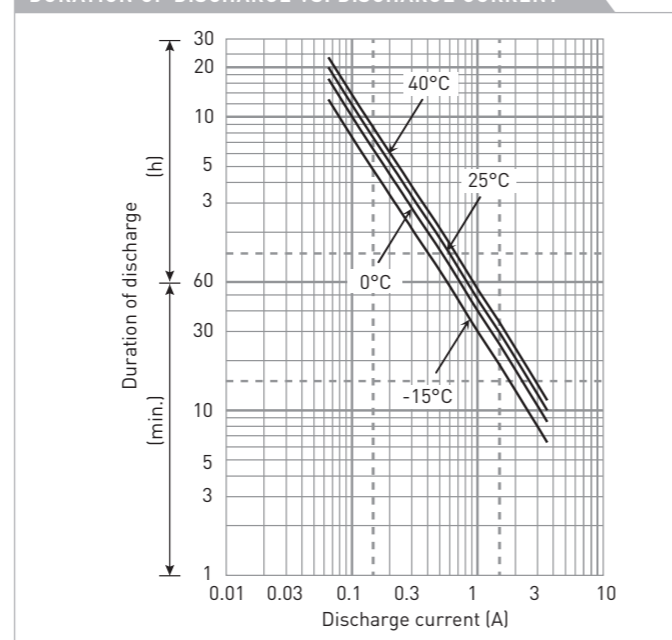

WATT TABLE (25°C)

Cut-off	(Wattage/battery)															
	3min.	5min.	10min.	15min.	20min.	30min.	45min.	1h	1.5h	2h	3h	4h	5h	6h	10h	20h
9.6V	78.1	61.6	40.2	30.7	25.8	19.2	13.6	10.8	7.49	5.73	4.32	3.30	2.73	2.22	1.46	0.787
9.9V	72.5	57.8	39.4	30.5	25.3	19.0	13.5	10.7	7.34	5.68	4.30	3.28	2.70	2.21	1.45	0.784
10.2V	66.9	54.2	38.4	29.9	24.9	18.8	13.4	10.6	7.19	5.54	4.25	3.26	2.68	2.19	1.44	0.782
10.5V	59.4	48.5	35.6	27.8	23.7	18.4	13.1	10.4	7.04	5.34	4.19	3.25	2.66	2.17	1.43	0.780
10.8V	50.2	42.9	31.7	26.0	23.0	17.7	12.9	10.2	6.82	5.13	4.08	3.24	2.60	2.16	1.41	0.758

AMPERE TABLE (25°C)

Cut-off	(Ampere/battery)															
	3min.	5min.	10min.	15min.	20min.	30min.	45min.	1h	1.5h	2h	3h	4h	5h	6h	10h	20h
9.6V	7.02	5.53	3.59	2.67	2.22	1.64	1.16	0.921	0.634	0.484	0.363	0.276	0.228	0.185	0.122	0.0655
9.9V	6.52	5.18	3.52	2.65	2.18	1.63	1.15	0.912	0.621	0.480	0.361	0.274	0.226	0.184	0.121	0.0654
10.2V	6.01	4.86	3.43	2.60	2.15	1.61	1.14	0.903	0.609	0.468	0.358	0.273	0.224	0.183	0.120	0.0652
10.5V	5.34	4.35	3.18	2.42	2.04	1.57	1.12	0.885	0.596	0.451	0.352	0.272	0.222	0.182	0.119	0.0650
10.8V	4.51	3.85	2.83	2.26	1.99	1.52	1.10	0.867	0.578	0.433	0.343	0.271	0.217	0.181	0.117	0.0632

All mentioned values are average values

LC-R121R3P*1

CHARGING METHOD (25°C)

Cycle use Control voltage: 14.5V - 14.9V
Initial current: 0.52A or smaller

CUT-OFF VOLTAGE

Discharge current	0.065A - 0.26A	0.26A - 0.65A	0.65A - 1.3A	1.3A - 2.6A	2.6A - 3.9A
Cut-off voltage	10.5V	10.2V	9.9V	9.3V	8.7V

CYCLE LIFE VS. DEPTH OF DISCHARGE (ACC. IEC 61056)

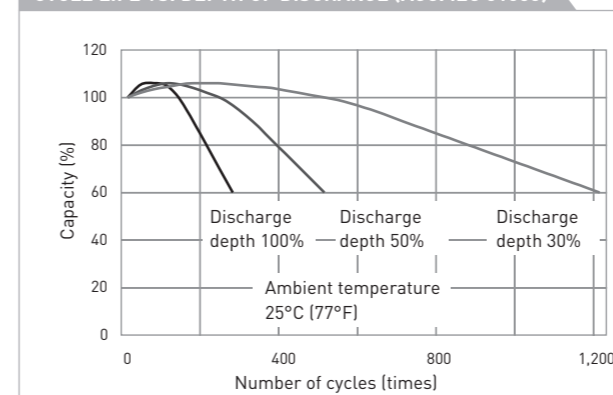

RESIDUAL CAPACITY TEST RESULT

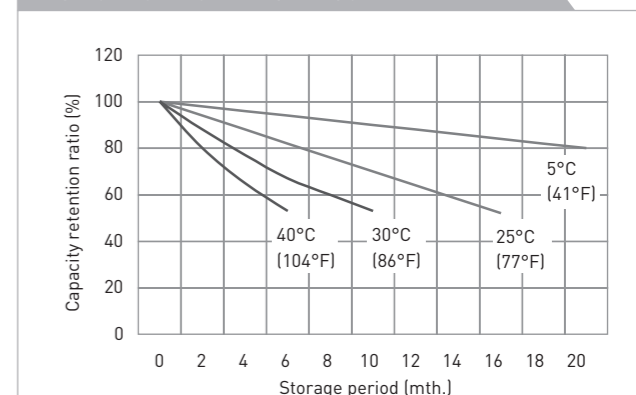

CONSTANT-VOLTAGE CONSTANT-CURRENT CHARGE CHARACTERISTICS FOR CYCLE USE

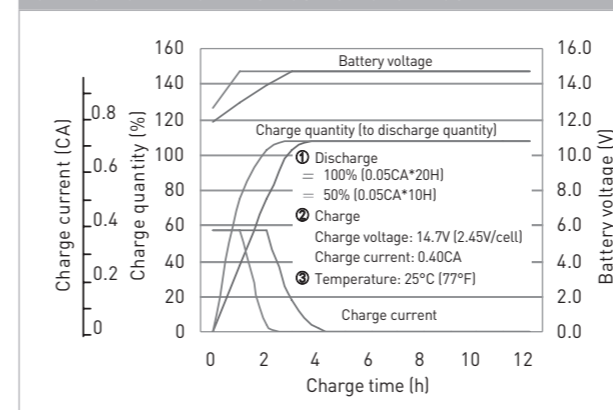

DISCHARGE CAPACITY BY TEMPERATURE AND BY DISCHARGE CURRENT

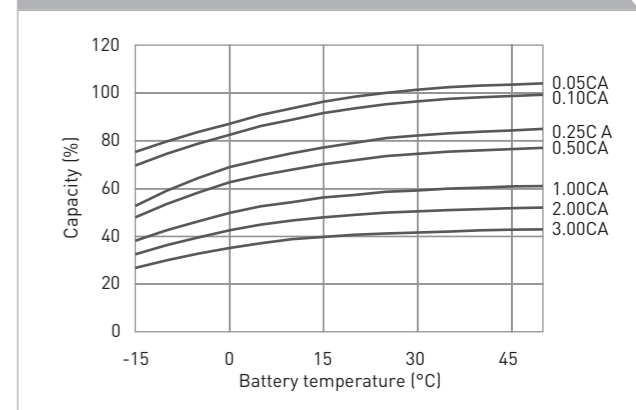

DISCHARGE CHARACTERISTICS

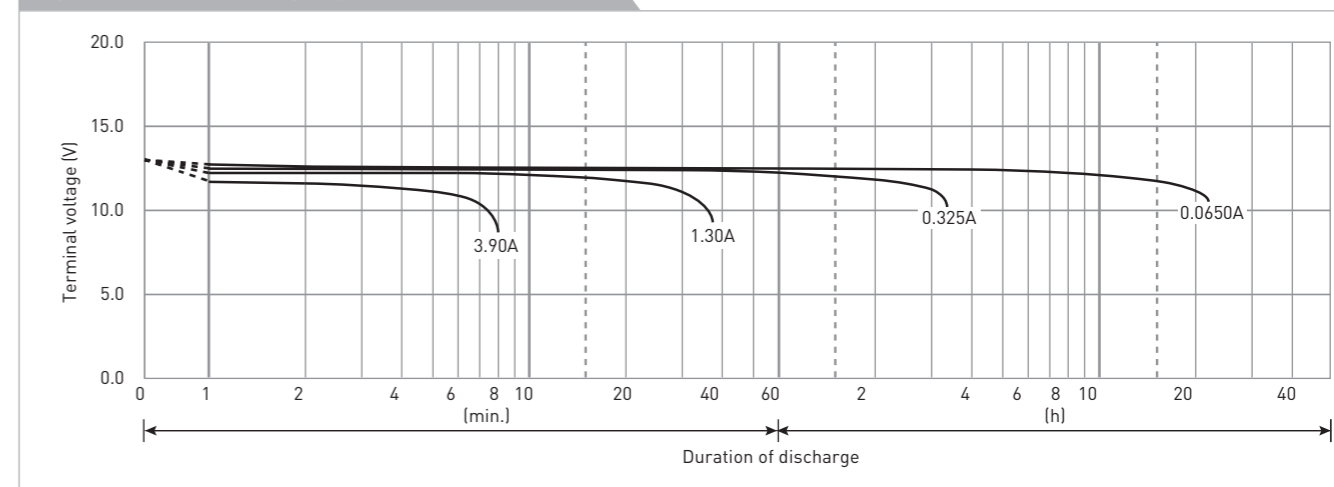

The data in this document are for descriptive purposes only and are not intended to make or imply any guarantee or warranty. Regarding handling and safety please consult our VRLA technical handbook chapter 1.

LC-R122R2P*1

DIMENSIONS (MM)



FOR MAIN AND STANDBY POWER SUPPLIES.
EXPECTED TRICKLE DESIGN LIFE: 6 - 9 YEARS AT 20°C
ACCORDING TO EUROBAT.



G188151

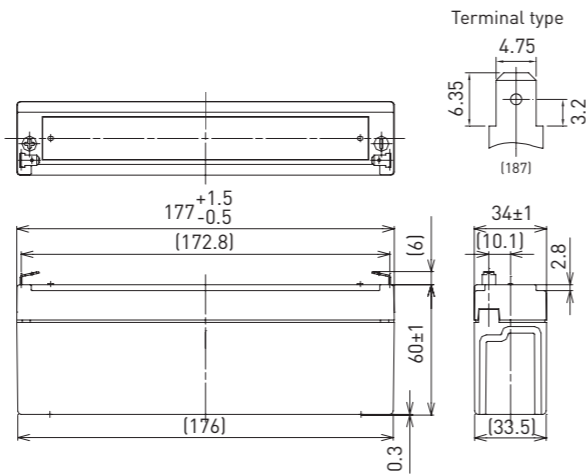

Battery case resin: standard (UL94 HB)

Contents indicated (including the recycle marking, etc.) are subject to change without notice.

SPECIFICATIONS

Name	LC-R122R2PG*1	
Nominal voltage	12V	
Nominal capacity (20 hour rate)	2.2Ah	
Dimensions	Length	177mm
	Width	34mm
	Height	66mm
Approx. mass	0.80kg	
Terminal	Faston 187	
Capacity (25°C)	20 hour rate	2.2Ah
	10 hour rate	2.0Ah
	3 hour rate	1.8Ah
	1 hour rate	1.5Ah
Impedance	Fully charged battery (25°C)	70mΩ
	40°C	102%
Temperature dependency of capacity (20 hour rate)	25°C	100%
	0°C	85%
	-15°C	65%
	After 3 month	91%
Self-discharge (25°C)	After 6 month	82%
	After 12 month	64%

DURATION OF DISCHARGE VS. DISCHARGE CURRENT

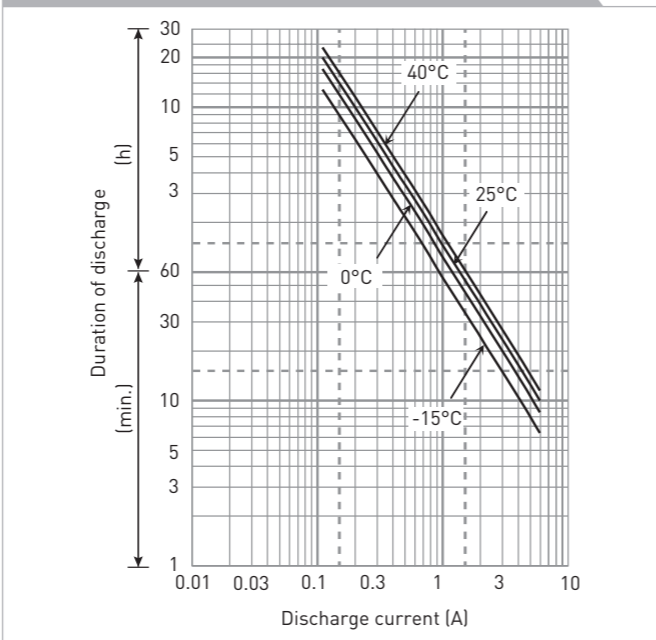

WATT TABLE (25°C)

Cut-off	(Wattage/battery)															
	3min.	5min.	10min.	15min.	20min.	30min.	45min.	1h	1.5h	2h	3h	4h	5h	6h	10h	20h
9.6V	132	104	68.1	52.0	43.6	32.5	23.0	18.4	12.6	9.77	7.27	5.59	4.61	3.71	2.46	1.33
9.9V	123	97.8	66.7	51.7	42.9	32.2	22.8	18.2	12.4	9.70	7.24	5.55	4.58	3.69	2.45	1.33
10.2V	113	91.6	65.0	50.6	42.2	31.8	22.6	18.0	12.1	9.44	7.16	5.51	4.54	3.66	2.42	1.32
10.5V	101	82.1	60.2	47.1	40.1	31.1	22.2	17.6	11.9	9.12	7.05	5.48	4.50	3.62	2.41	1.32
10.8V	84.9	72.6	53.7	43.9	39.0	30.0	21.9	17.3	11.5	8.68	6.91	5.40	4.39	3.56	2.38	1.31

AMPERE TABLE (25°C)

Cut-off	(Ampere/battery)															
	3min.	5min.	10min.	15min.	20min.	30min.	45min.	1h	1.5h	2h	3h	4h	5h	6h	10h	20h
9.6V	11.9	9.35	6.08	4.52	3.76	2.78	1.96	1.56	1.07	0.825	0.611	0.468	0.385	0.309	0.205	0.111
9.9V	11.0	8.77	5.96	4.49	3.70	2.75	1.94	1.55	1.05	0.819	0.608	0.464	0.382	0.308	0.204	0.111
10.2V	10.2	8.22	5.81	4.40	3.64	2.72	1.93	1.53	1.03	0.798	0.602	0.461	0.379	0.306	0.202	0.110
10.5V	9.04	7.36	5.38	4.09	3.45	2.66	1.89	1.50	1.01	0.770	0.593	0.458	0.376	0.302	0.201	0.110
10.8V	7.64	6.51	4.80	3.82	3.36	2.57	1.86	1.47	0.978	0.733	0.581	0.452	0.367	0.297	0.199	0.109

All mentioned values are average values

LC-R122R2P*1

CHARGING METHOD (25°C)

Cycle use Control voltage: 14.5V - 14.9V
Initial current: 0.88A or smaller

CUT-OFF VOLTAGE

Discharge current	0.110A - 0.440A	0.440A - 1.10A	1.10A - 2.20A	2.00A - 4.40A	4.40A - 6.60A
Cut-off voltage	10.5V	10.2V	9.9V	9.3V	8.7V

CYCLE LIFE VS. DEPTH OF DISCHARGE (ACC. IEC 61056)

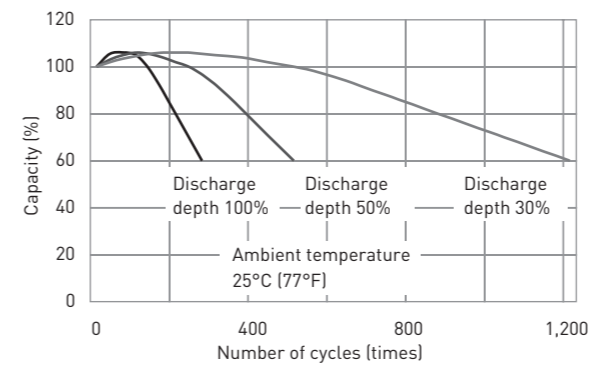

RESIDUAL CAPACITY TEST RESULT

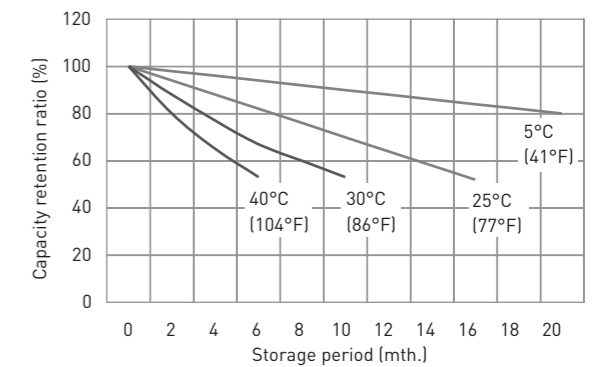

CONSTANT-VOLTAGE CONSTANT-CURRENT CHARGE CHARACTERISTICS FOR CYCLE USE

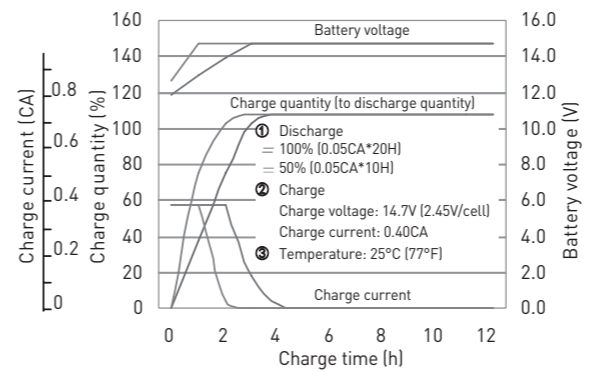

DISCHARGE CAPACITY BY TEMPERATURE AND BY DISCHARGE CURRENT

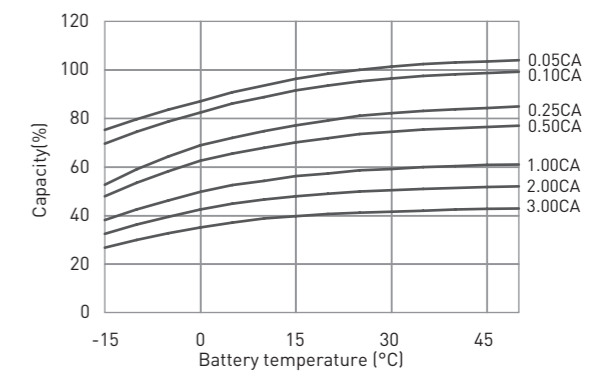

DISCHARGE CHARACTERISTICS

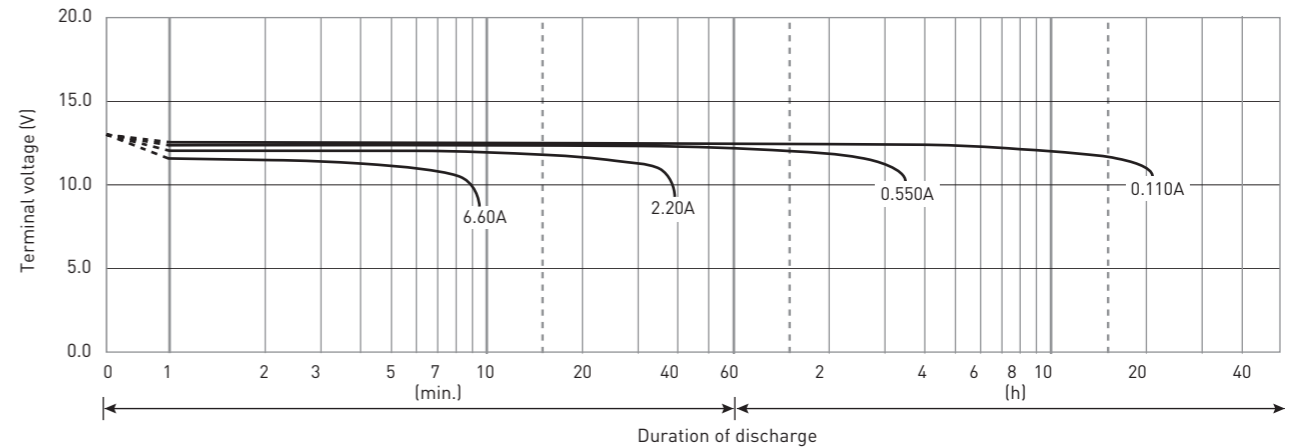

The data in this document are for descriptive purposes only and are not intended to make or imply any guarantee or warranty. Regarding handling and safety please consult our VRLA technical handbook chapter 1.

LC-R123R4P*1

DIMENSIONS (MM)



Contents indicated (including the recycle marking, etc.) are subject to change without notice.

FOR MAIN AND STANDBY POWER SUPPLIES.
EXPECTED TRICKLE DESIGN LIFE: 6 - 9 YEARS AT 20°C
ACCORDING TO EUROBAT.



G191053

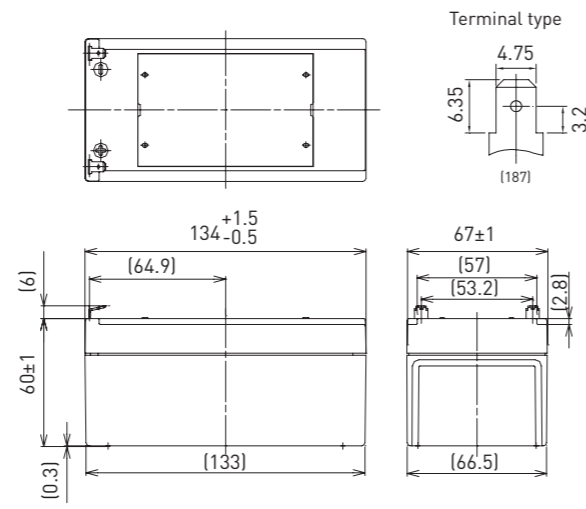

Battery case resin: standard (UL94 HB)

SPECIFICATIONS

Name	LC-R123R4PG*1	
Nominal voltage	12V	
Nominal capacity (20 hour rate)	3.4Ah	
Dimensions	Length	134mm
	Width	67mm
	Height	66mm
Approx. mass	1.15kg	
Terminal	Faston 187	
Capacity (25°C)	20 hour rate	3.4Ah
	10 hour rate	3.1Ah
	3 hour rate	2.8Ah
	1 hour rate	2.3Ah
Impedance	Fully charged battery (25°C)	50mΩ
	40°C	102%
Temperature dependency of capacity (20 hour rate)	25°C	100%
	0°C	85%
	-15°C	65%
	After 3 month	91%
Self-discharge (25°C)	After 6 month	82%
	After 12 month	64%

DURATION OF DISCHARGE VS. DISCHARGE CURRENT

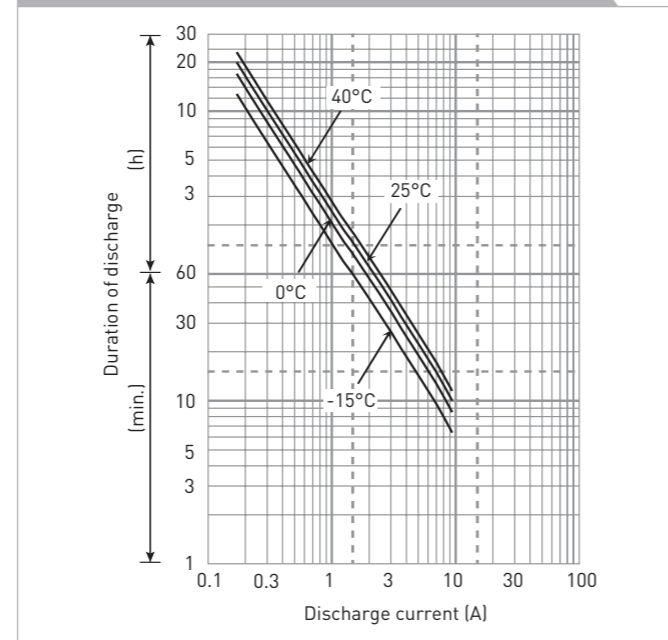

WATT TABLE (25°C)

Cut-off	3min.	5min.	10min.	15min.	20min.	30min.	45min.	1h	1.5h	2h	3h	4h	5h	6h	10h	20h
9.6V	204	161	105	80.4	67.4	50.3	35.5	28.4	19.6	15.0	11.3	8.63	7.13	5.80	3.81	2.06
9.9V	190	151	103	79.8	66.3	49.7	35.3	28.1	19.2	14.9	11.2	8.58	7.07	5.78	3.80	2.05
10.2V	175	142	100	78.2	65.2	49.2	34.9	27.8	18.8	14.5	11.1	8.52	7.01	5.73	3.76	2.05
10.5V	155	127	93.1	72.8	61.9	48.1	34.4	27.3	18.4	14.0	11.0	8.49	6.96	5.66	3.74	2.04
10.8V	131	112	83.0	67.9	60.3	46.4	33.8	26.7	17.8	13.4	10.7	8.46	6.79	5.66	3.68	1.98

AMPERE TABLE (25°C)

Cut-off	3min.	5min.	10min.	15min.	20min.	30min.	45min.	1h	1.5h	2h	3h	4h	5h	6h	10h	20h
9.6V	18.4	14.4	9.40	6.99	5.81	4.30	3.02	2.41	1.66	1.26	0.949	0.722	0.595	0.484	0.318	0.171
9.9V	17.0	13.6	9.21	6.94	5.71	4.25	3.00	2.39	1.62	1.24	0.945	0.718	0.590	0.482	0.316	0.171
10.2V	15.7	12.7	8.97	6.80	5.62	4.20	2.97	2.36	1.59	1.22	0.935	0.713	0.586	0.478	0.313	0.170
10.5V	14.0	11.4	8.31	6.33	5.34	4.11	2.93	2.31	1.56	1.18	0.921	0.710	0.581	0.475	0.312	0.170
10.8V	11.8	10.1	7.41	5.90	5.19	3.97	2.88	2.27	1.51	1.13	0.897	0.708	0.567	0.472	0.307	0.165

All mentioned values are average values

LC-R123R4P*1

CHARGING METHOD (25°C)

Cycle use Control voltage: 14.5V - 14.9V
Initial current: 1.36A or smaller

CUT-OFF VOLTAGE

Discharge current	0.170A - 0.680A	0.680A - 1.70A	1.70A - 3.40A	3.40A - 6.80A	6.80A - 10.2A
Cut-off voltage	10.5V	10.2V	9.9V	9.3V	8.7V

CYCLE LIFE VS. DEPTH OF DISCHARGE (ACC. IEC 61056)

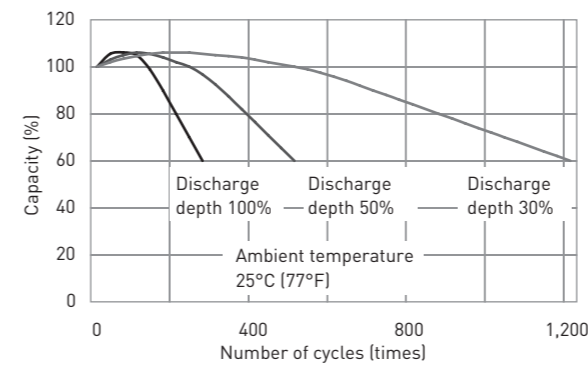

RESIDUAL CAPACITY TEST RESULT

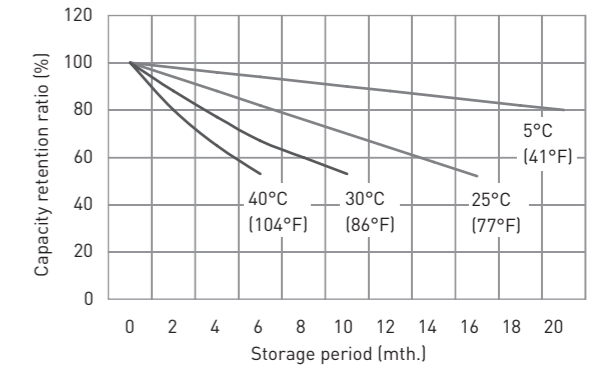

CONSTANT-VOLTAGE CONSTANT-CURRENT CHARGE CHARACTERISTICS FOR CYCLE USE

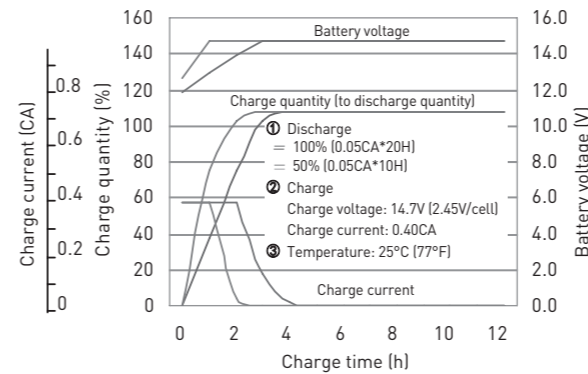

DISCHARGE CAPACITY BY TEMPERATURE AND BY DISCHARGE CURRENT

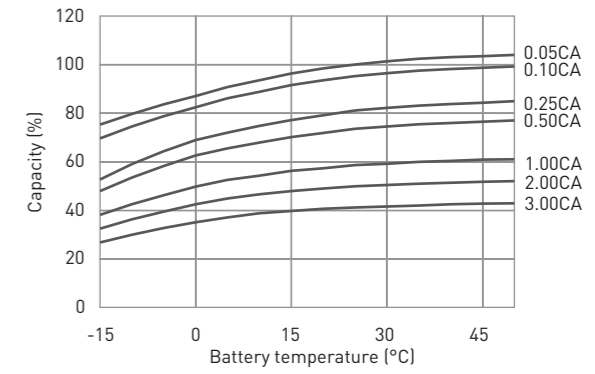

DISCHARGE CHARACTERISTICS

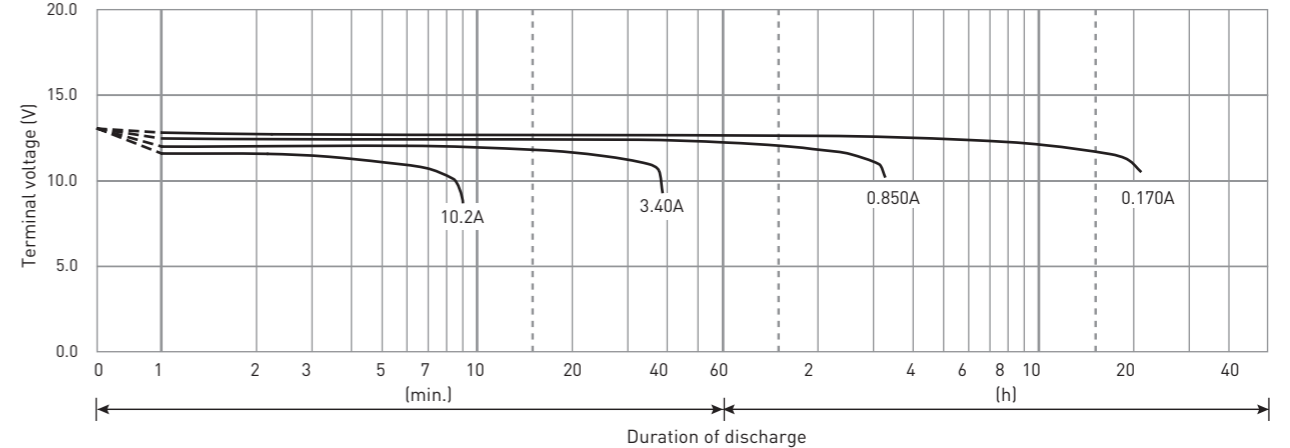

The data in this document are for descriptive purposes only and are not intended to make or imply any guarantee or warranty. Regarding handling and safety please consult our VRLA technical handbook chapter 1.

LC-R124R5P*1

DIMENSIONS (MM)



FOR MAIN AND STANDBY POWER SUPPLIES.
EXPECTED TRICKLE DESIGN LIFE: 6 - 9 YEARS AT 20°C
ACCORDING TO EUROBAT.

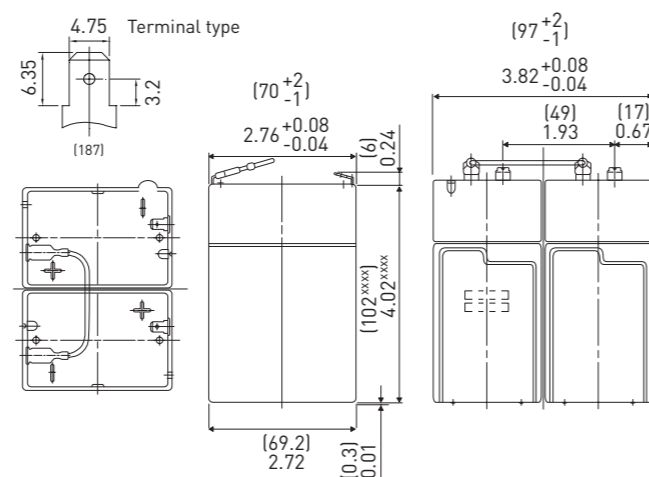

Battery case resin: standard (UL94 HB)

Contents indicated (including the recycle marking, etc.) are subject to change without notice.

SPECIFICATIONS

Name	LC-R124R5P*1	
Nominal voltage	12V	
Nominal capacity (20 hour rate)	4.5Ah	
Dimensions	Length	70mm
	Width	97mm
	Height	108mm
Approx. mass	5.0kg	
Terminal	Faston 187	
Capacity (25°C)	20 hour rate	4.5Ah
	10 hour rate	4.1Ah
	3 hour rate	3.6Ah
	1 hour rate	3.1Ah
Impedance	Fully charged battery (25°C)	40mΩ
	40°C	102%
Temperature dependency of capacity (20 hour rate)	25°C	100%
	0°C	85%
	-15°C	65%
	Self-discharge (25°C)	After 3 month
	After 6 month	83%
	After 12 month	64%

DURATION OF DISCHARGE VS. DISCHARGE CURRENT

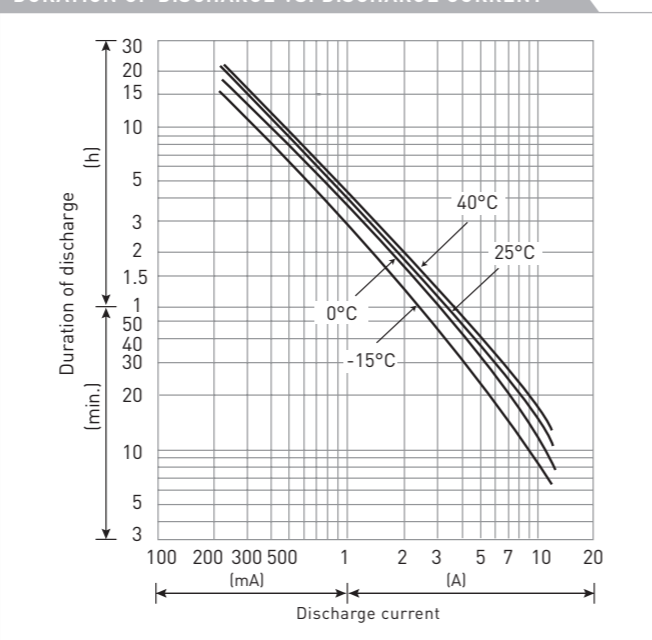

WATT TABLE (25°C)

Cut-off	[Wattage/battery]															
	3min.	5min.	10min.	15min.	20min.	30min.	45min.	1h	1.5h	2h	3h	4h	5h	6h	10h	20h
9.6V	270	214	139.4	106.4	89.2	66.6	47	37.6	25.8	19.98	14.88	11.42	9.44	7.58	5.02	2.72
9.9V	250	200	136.6	105.6	87.8	65.8	46.6	37.6	25.4	19.84	14.8	11.36	9.36	7.56	5	2.72
10.2V	232	188	133	103.6	86.2	65	46.2	36.8	24.8	19.32	14.66	11.28	9.28	7.5	4.96	2.7
10.5V	206	168	123.2	96.4	82	63.6	45.4	36	24.2	18.64	14.42	11.2	9.2	7.4	4.92	2.7
10.8V	174	148	110	89.8	79.8	61.4	44.8	35.4	23.6	17.76	14.14	11.06	8.98	7.28	4.88	2.68

AMPERE TABLE (25°C)

Cut-off	[Ampere/battery]															
	3min.	5min.	10min.	15min.	20min.	30min.	45min.	1h	1.5h	2h	3h	4h	5h	6h	10h	20h
9.6V	24.3	19.13	12.44	9.25	7.69	5.69	4.00	3.19	2.19	1.69	1.25	0.956	0.788	0.633	0.419	0.227
9.9V	22.6	17.94	12.19	9.19	7.56	5.63	3.98	3.19	2.14	1.68	1.24	0.950	0.781	0.630	0.417	0.226
10.2V	20.8	16.81	11.88	9.00	7.44	5.56	3.94	3.13	2.10	1.63	1.23	0.944	0.775	0.625	0.413	0.226
10.5V	18.5	15.06	11.00	8.38	7.06	5.44	3.88	3.06	2.06	1.58	1.21	0.938	0.769	0.618	0.411	0.225
10.8V	15.6	13.31	9.81	7.81	6.88	5.25	3.81	3.00	2.00	1.50	1.19	0.925	0.750	0.608	0.406	0.224

All mentioned values are average values

LC-R124R5P*1

CHARGING METHOD (25°C)

Cycle use	Control voltage: 14.5V - 14.9V
	Initial current: 1.80A or smaller

CUT-OFF VOLTAGE

Discharge current	0.225A - 0.9A	0.9A - 2.25A	2.25A - 4.5A	4.5A - 9.0A	9.0A - 13.5A
Cut-off voltage	10.5V	10.2V	9.9V	9.3V	8.7V

CYCLE LIFE VS. DEPTH OF DISCHARGE (ACC. IEC 61056)

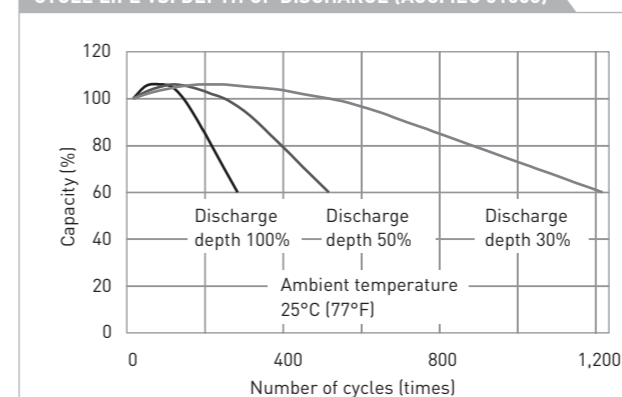

RESIDUAL CAPACITY TEST RESULT

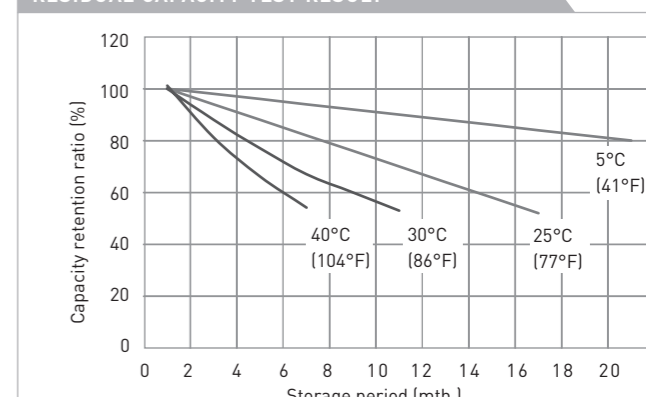

CONSTANT-VOLTAGE CONSTANT-CURRENT CHARGE CHARACTERISTICS FOR CYCLE USE

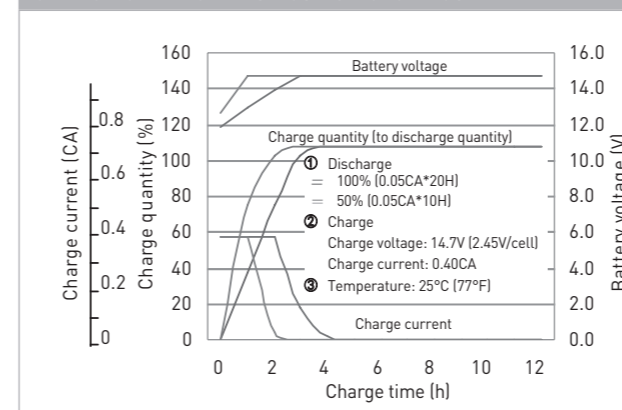

DISCHARGE CAPACITY BY TEMPERATURE AND BY DISCHARGE CURRENT

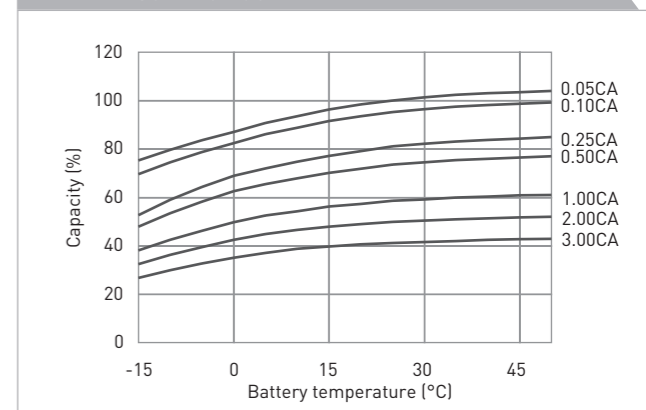

DISCHARGE CHARACTERISTICS

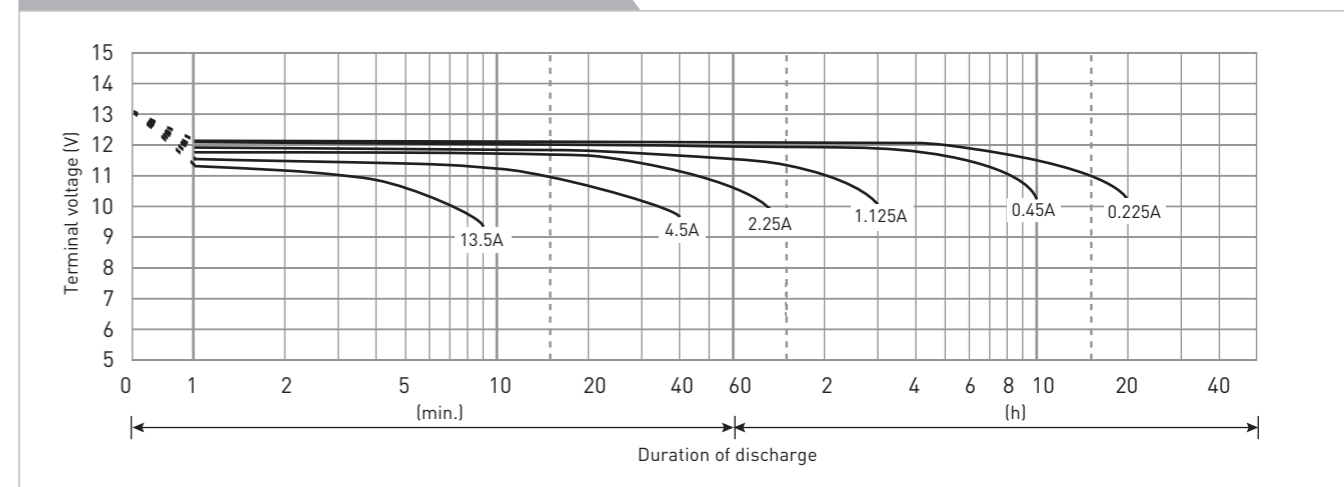

The data in this document are for descriptive purposes only and are not intended to make or imply any guarantee or warranty. Regarding handling and safety please consult our VRLA technical handbook chapter 1.

LC-R127R2P*1

DIMENSIONS (MM)



FOR MAIN AND STANDBY POWER SUPPLIES.
EXPECTED TRICKLE DESIGN LIFE: 6 - 9 YEARS AT 20°C
ACCORDING TO EUROBAT.



G193046

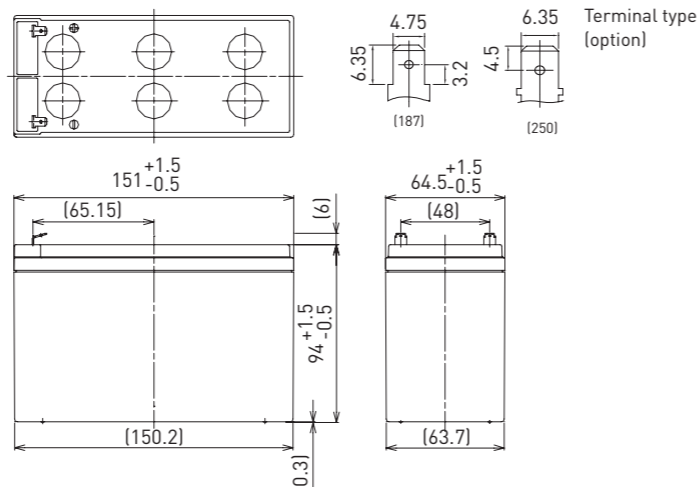

Battery case resin: standard (UL94 HB)

Contents indicated (including the recycle marking, etc.) are subject to change without notice.

SPECIFICATIONS

Name	LC-R127R2PG/PG1*
Nominal voltage	12V
Nominal capacity (20 hour rate)	7.2Ah
Dimensions	Length: 151mm
	Width: 64.5mm
	Height: 100mm
Approx. mass	2.50kg
Terminal	Faston 187/250
Capacity (25°C)	20 hour rate: 7.2Ah
	10 hour rate: 6.6Ah
	3 hour rate: 5.8Ah
	1 hour rate: 4.9Ah
Impedance	Fully charged battery (25°C): 21mΩ
	40°C: 102%
Temperature dependency of capacity (20 hour rate)	25°C: 100%
	0°C: 85%
	-15°C: 65%
Self-discharge (25°C)	After 3 month: 91%
	After 6 month: 82%
	After 12 month: 64%

DURATION OF DISCHARGE VS. DISCHARGE CURRENT

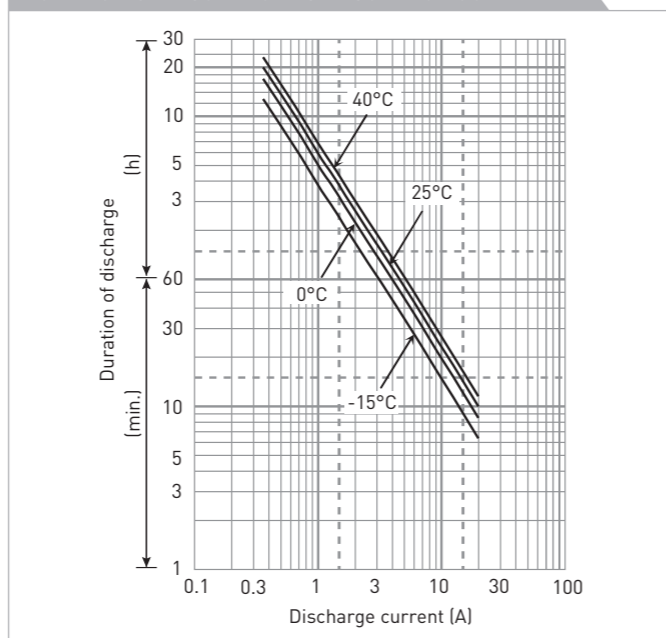

WATT TABLE (25°C)

Cut-off	3min.	5min.	10min.	15min.	20min.	30min.	45min.	1h	1.5h	2h	3h	4h	5h	6h	10h	20h
9.6V	430	335	220	167	134	98.4	72.1	56.5	44.6	34.7	24.7	19.2	15.4	12.8	8.39	4.60
9.9V	405	287	187	159	130	96.4	71.6	55.1	43.7	34.4	24.5	19.1	15.3	12.5	8.35	4.59
10.2V	379	273	182	151	126	94.3	68.6	53.6	41.4	32.5	23.5	18.7	14.6	12.2	8.00	4.43
10.5V	343	248	174	144	120	90.8	66.8	52.4	39.8	31.5	23.0	18.3	14.5	12.1	7.96	4.42
10.8V	308	223	164	138	115	87.2	62.6	48.4	37.2	28.1	21.4	16.9	13.3	11.2	7.41	4.13

AMPERE TABLE (25°C)

Cut-off	3min.	5min.	10min.	15min.	20min.	30min.	45min.	1h	1.5h	2h	3h	4h	5h	6h	10h	20h
9.6V	38.9	30.6	19.9	14.8	12.3	9.10	6.40	5.10	3.50	2.70	2.00	1.53	1.26	1.02	0.670	0.363
9.9V	36.1	28.7	19.5	14.7	12.1	9.00	6.36	5.05	3.43	2.68	1.99	1.52	1.25	1.01	0.667	0.362
10.2V	34.2	26.9	19.0	14.4	11.9	8.90	6.30	5.00	3.36	2.61	1.97	1.51	1.24	1.00	0.660	0.361
10.5V	31.4	24.1	17.6	13.4	11.3	8.70	6.20	4.90	3.29	2.52	1.94	1.50	1.23	0.988	0.657	0.360
10.8V	29.0	22.3	15.7	12.5	11.0	8.40	6.10	4.80	3.20	2.40	1.90	1.48	1.20	0.972	0.650	0.358

All mentioned values are average values

LC-R127R2P*1

CHARGING METHOD (25°C)

Cycle use: Control voltage: 14.5V - 14.9V
Initial current: 2.88A or smaller

CUT-OFF VOLTAGE

Discharge current	0.360A - 1.44A	1.44A - 3.60A	3.60A - 7.20A	7.20A - 14.4A	14.4A - 21.6A
Cut-off voltage	10.5V	10.2V	9.9V	9.3V	8.7V

CYCLE LIFE VS. DEPTH OF DISCHARGE (ACC. IEC 61056)

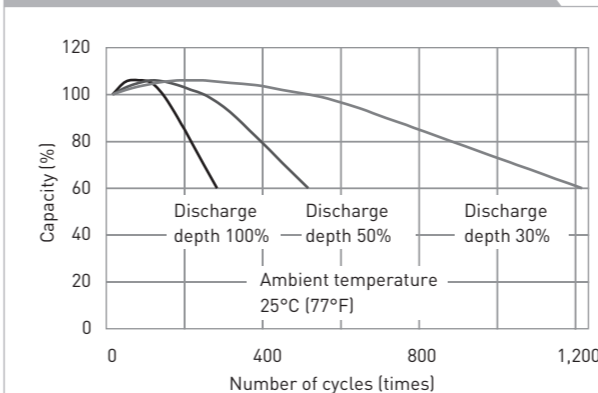

RESIDUAL CAPACITY TEST RESULT

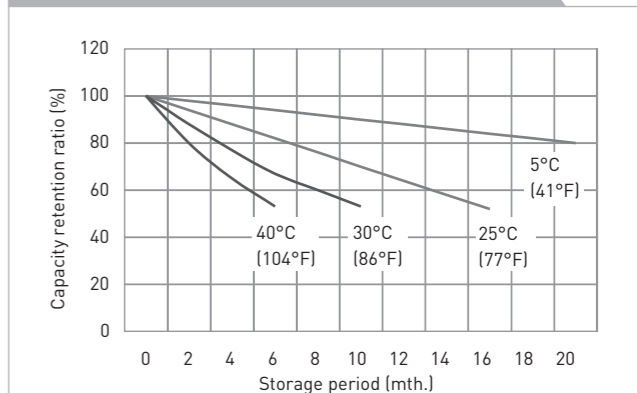

CONSTANT-VOLTAGE CONSTANT-CURRENT CHARGE CHARACTERISTICS FOR CYCLE USE

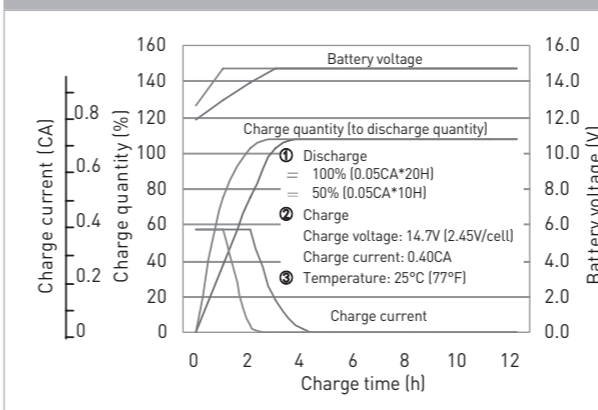

DISCHARGE CAPACITY BY TEMPERATURE AND BY DISCHARGE CURRENT

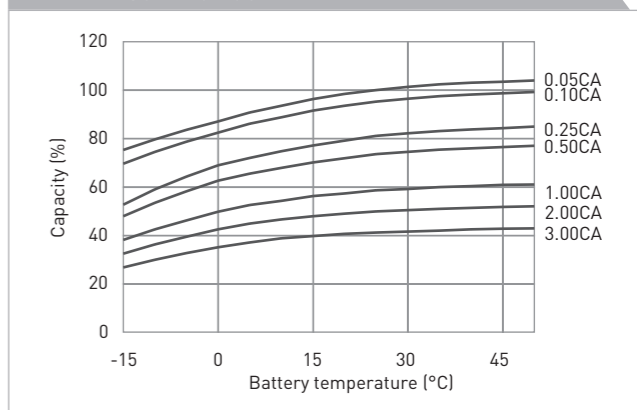

DISCHARGE CHARACTERISTICS

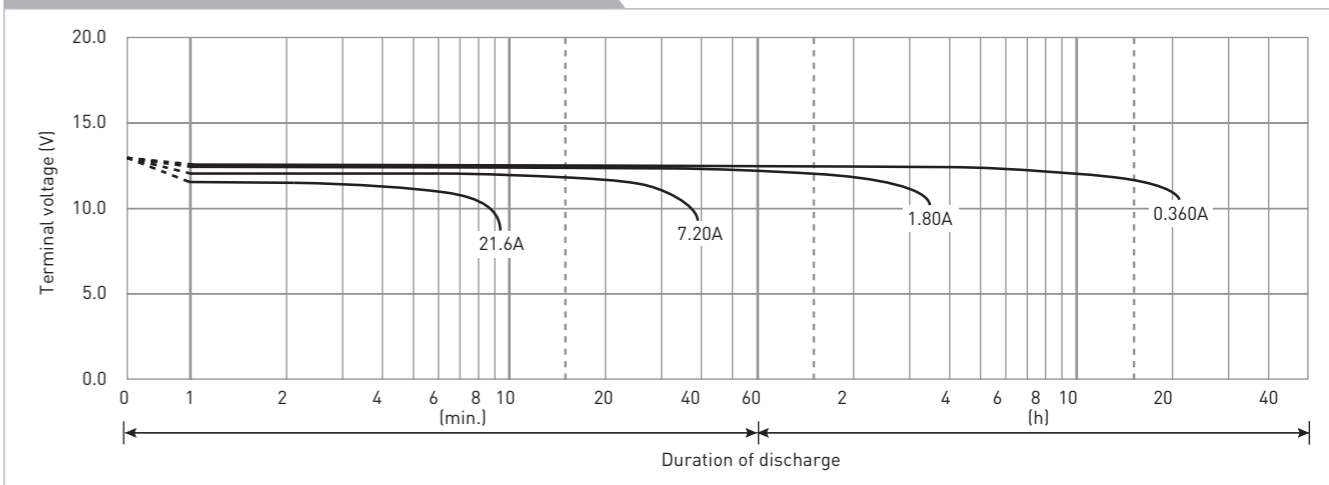

The data in this document are for descriptive purposes only and are not intended to make or imply any guarantee or warranty. Regarding handling and safety please consult our VRLA technical handbook chapter 1.

LC-RA1212P*1

DIMENSIONS (MM)



FOR MAIN AND STANDBY POWER SUPPLIES.
EXPECTED TRICKLE DESIGN LIFE: 6 - 9 YEARS AT 20°C
ACCORDING TO EUROBAT.



G100001

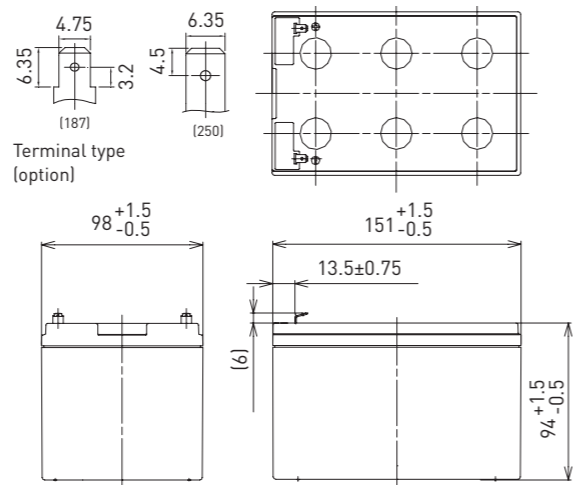

Battery case resin: standard (UL94 HB)

Contents indicated (including the recycle marking, etc.) are subject to change without notice.

SPECIFICATIONS

Name	LC-RA1212PG/PG1*1	
Nominal voltage	12V	
Nominal capacity (20 hour rate)	12Ah	
Dimensions	Length 151mm	
	Width 98mm	
	Height 100mm	
Approx. mass	3.85kg	
Terminal	Faston 187/250	
Capacity (25°C)	20 hour rate 12Ah	
	10 hour rate 11Ah	
	3 hour rate 9.3Ah	
	1 hour rate 8.5Ah	
Impedance	Fully charged battery (25°C) 15mΩ	
	Temperature dependency of capacity (20 hour rate)	
Self-discharge (25°C)	40°C 102%	
	25°C 100%	
	0°C 85%	
	-15°C 65%	
After 3 month	91%	
	After 6 month	82%
	After 12 month	64%

DURATION OF DISCHARGE VS. DISCHARGE CURRENT

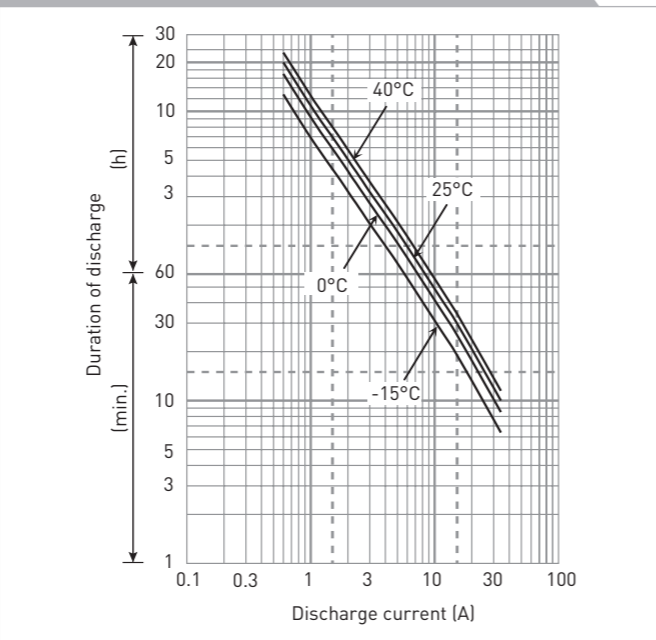

WATT TABLE (25°C)

Cut-off	[Wattage/battery]															
	3min.	5min.	10min.	15min.	20min.	30min.	45min.	1h	1.5h	2h	3h	4h	5h	6h	10h	20h
9.6V	679	559	384	298	247	183	137	105	70.3	54.5	38.1	28.8	24.1	21.7	13.3	7.22
9.9V	649	537	373	288	241	177	135	104	69.9	54.2	37.8	28.7	24.0	21.7	13.3	7.22
10.2V	607	506	363	282	235	175	134	102	69.1	53.9	37.5	28.6	23.9	21.6	13.2	7.21
10.5V	556	475	343	271	231	172	133	100	68.5	53.3	36.9	28.5	23.8	21.6	13.2	7.20
10.8V	495	434	321	261	225	166	123	97.8	66.1	52.1	36.3	28.4	23.7	21.5	13.1	7.18

AMPERE TABLE (25°C)

Cut-off	[Ampere/battery]															
	3min.	5min.	10min.	15min.	20min.	30min.	45min.	1h	1.5h	2h	3h	4h	5h	6h	10h	20h
9.6V	61.1	50.1	34.3	25.9	21.3	15.6	11.7	8.90	5.95	4.60	3.20	2.41	2.01	1.81	1.11	0.602
9.9V	58.4	48.2	33.3	25.0	20.8	15.1	11.5	8.80	5.92	4.58	3.18	2.40	2.01	1.81	1.11	0.602
10.2V	54.6	45.4	32.4	24.5	20.3	14.9	11.4	8.70	5.85	4.55	3.15	2.39	2.00	1.80	1.10	0.601
10.5V	50.0	42.6	30.6	23.6	19.9	14.7	11.3	8.50	5.80	4.50	3.10	2.38	2.00	1.80	1.10	0.600
10.8V	44.5	38.9	28.7	22.7	19.4	14.2	10.5	8.30	5.60	4.40	3.05	2.37	1.99	1.79	1.09	0.598

All mentioned values are average values

LC-RA1212P*1

CHARGING METHOD (25°C)

Cycle use Control voltage: 14.5V - 14.9V
Initial current: 4.80A or smaller

CUT-OFF VOLTAGE

Discharge current	0.600A - 2.40A	2.40A - 6.00A	6.00A - 12.0A	12.0A - 24.0A	24.0A - 36.0A
Cut-off voltage	10.5V	10.2V	9.9V	9.3V	8.7V

CYCLE LIFE VS. DEPTH OF DISCHARGE (ACC. IEC 61056)

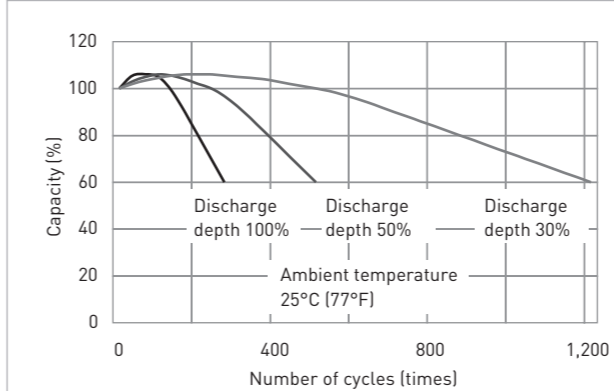

RESIDUAL CAPACITY TEST RESULT

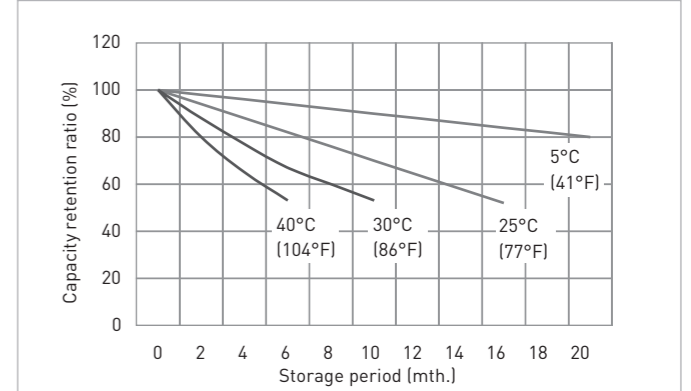

CONSTANT-VOLTAGE CONSTANT-CURRENT CHARGE CHARACTERISTICS FOR CYCLE USE

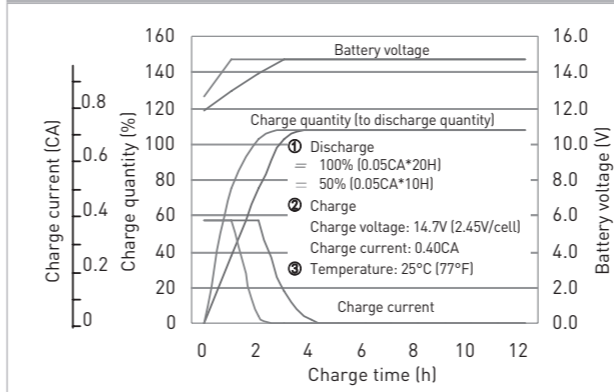

DISCHARGE CAPACITY BY TEMPERATURE AND BY DISCHARGE CURRENT

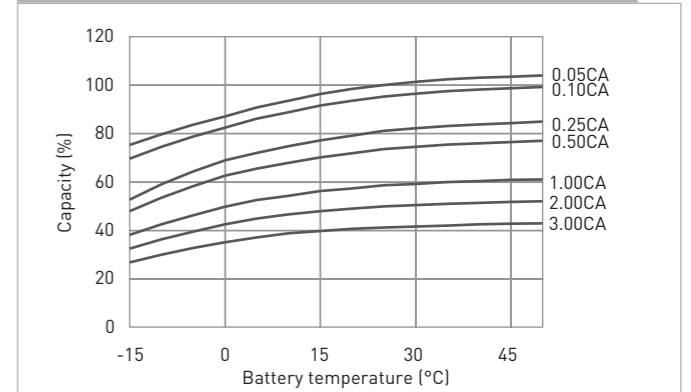

DISCHARGE CHARACTERISTICS

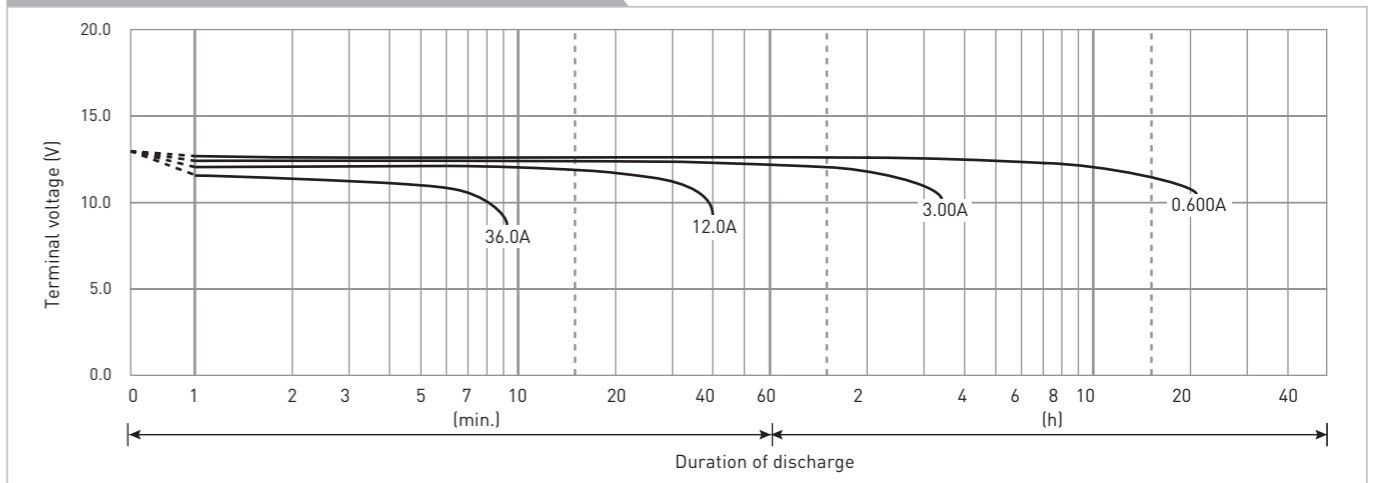

The data in this document are for descriptive purposes only and are not intended to make or imply any guarantee or warranty. Regarding handling and safety please consult our VRLA technical handbook chapter 1.

LC-RA1215P*1

DIMENSIONS (MM)



Contents indicated (including the recycle marking, etc.) are subject to change without notice.

FOR MAIN AND STANDBY POWER SUPPLIES.
EXPECTED TRICKLE DESIGN LIFE: 6 - 9 YEARS AT 20°C
ACCORDING TO EUROBAT.

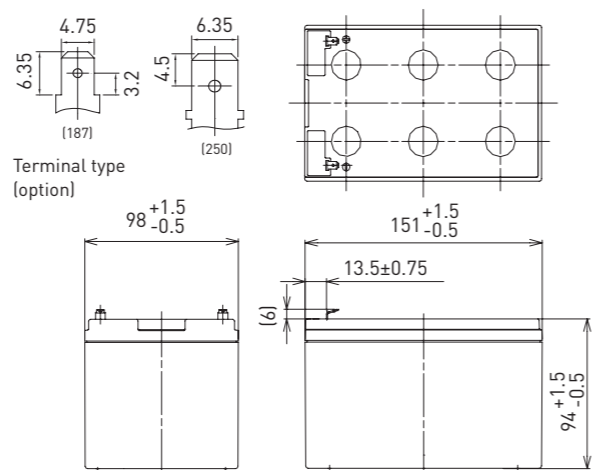

Battery case resin: standard (UL94 HB)

SPECIFICATIONS

Name	LC-RA1215P/P1*1
Nominal voltage	12V
Nominal capacity (20 hour rate)	15Ah
Dimensions	Length 151mm
	Width 98mm
	Height 100mm
Approx. mass	4.15kg
Terminal	Faston 187/250
Capacity (25°C)	20 hour rate 15Ah
	10 hour rate 13Ah
	3 hour rate 12Ah
	1 hour rate 10Ah
Impedance	Fully charged battery (25°C) 15mΩ
	Temperature dependency of capacity (20 hour rate)
Self-discharge (25°C)	40°C 102%
	25°C 100%
	0°C 85%
	-15°C 65%
Self-discharge (25°C)	After 3 month 91%
	After 6 month 82%
	After 12 month 64%

DURATION OF DISCHARGE VS. DISCHARGE CURRENT

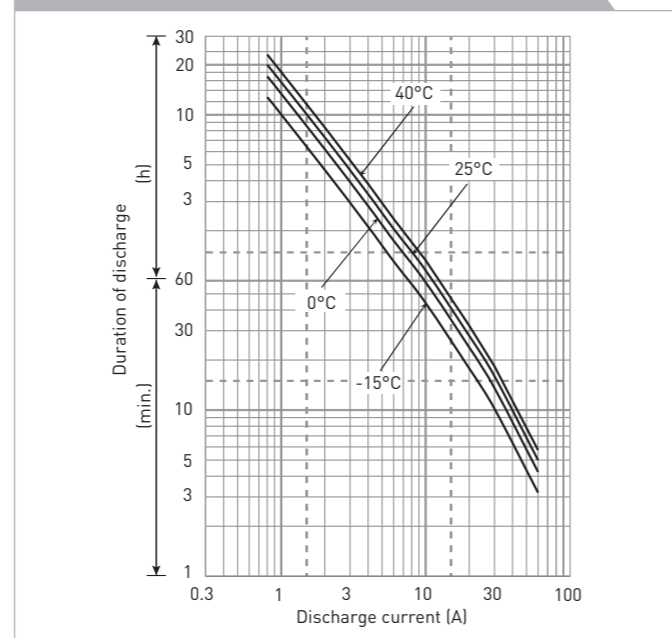

WATT TABLE (25°C)

Cut-off	[Wattage/battery]															
	3min.	5min.	10min.	15min.	20min.	30min.	45min.	1h	1.5h	2h	3h	4h	5h	6h	10h	20h
9.6V	850	682	455	350	292	217	157	123	83.9	65.0	47.1	36.0	29.9	25.2	16.2	8.75
9.9V	799	646	444	343	286	213	156	122	82.8	64.6	46.9	35.8	29.7	25.1	16.1	8.74
10.2V	741	607	433	336	281	211	154	121	81.4	63.4	46.4	35.7	29.5	24.9	15.9	8.72
10.5V	667	555	404	318	270	206	152	118	80.1	61.9	45.7	35.5	29.4	24.8	15.8	8.70
10.8V	576	497	368	300	263	199	146	116	77.7	59.6	44.8	35.1	28.9	24.5	15.7	8.66

AMPERE TABLE (25°C)

Cut-off	[Ampere/battery]															
	3min.	5min.	10min.	15min.	20min.	30min.	45min.	1h	1.5h	2h	3h	4h	5h	6h	10h	20h
9.6V	76.5	61.2	40.6	30.4	25.2	18.5	13.4	10.50	7.11	5.49	3.96	3.01	2.49	2.10	1.35	0.755
9.9V	71.8	58.0	39.7	29.9	24.7	18.2	13.3	10.40	7.01	5.45	3.94	3.00	2.48	2.09	1.34	0.753
10.2V	66.6	54.5	38.6	29.2	24.2	18.1	13.1	10.30	6.89	5.36	3.90	2.99	2.46	2.08	1.33	0.752
10.5V	59.9	49.8	36.1	27.6	23.3	17.6	13.0	10.00	6.78	5.22	3.84	2.97	2.45	2.07	1.32	0.750
10.8V	51.8	44.6	32.9	26.1	22.7	17.0	12.5	9.82	6.58	5.03	3.77	2.94	2.41	2.04	1.31	0.747

All mentioned values are average values

LC-RA1215P*1

CHARGING METHOD (25°C)

Cycle use Control voltage: 14.5V - 14.9V
Initial current: 6A or smaller

CUT-OFF VOLTAGE

Discharge current	0.75A - 3A	3A - 7.5A	7.5A - 15A	15A - 30A	30A - 45A
Cut-off voltage	10.5V	10.2V	9.9V	9.3V	8.7V

CYCLE LIFE VS. DEPTH OF DISCHARGE (ACC. IEC 61056)

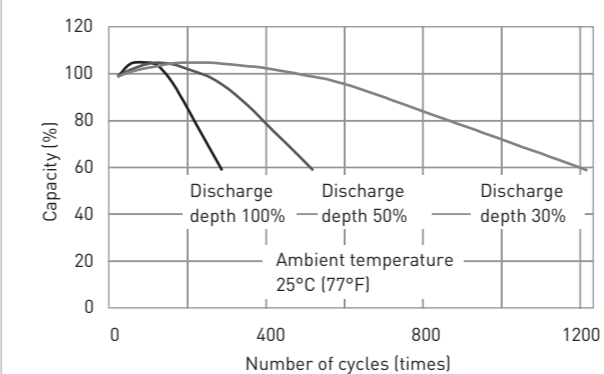

RESIDUAL CAPACITY TEST RESULT

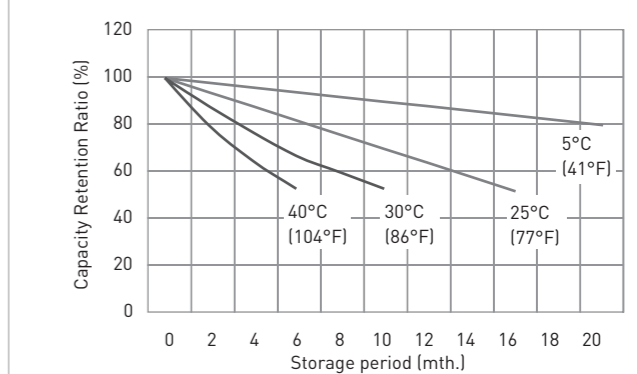

CONSTANT-VOLTAGE CONSTANT-CURRENT CHARGE CHARACTERISTICS FOR CYCLE USE

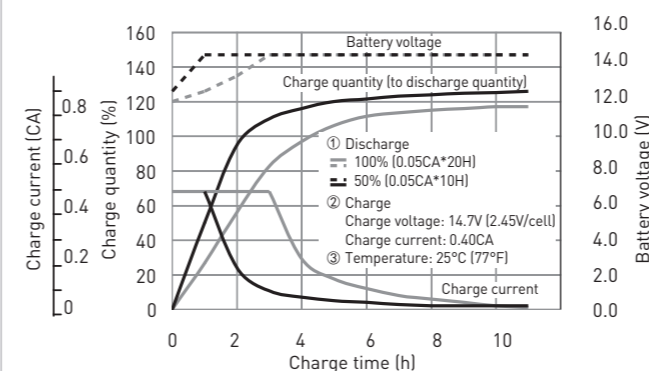

DISCHARGE CAPACITY BY TEMPERATURE AND BY DISCHARGE CURRENT

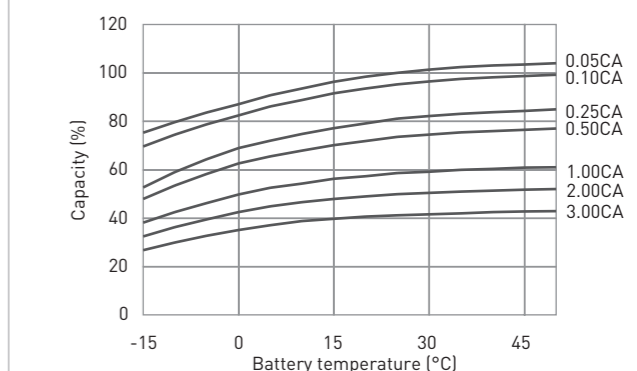

DISCHARGE CHARACTERISTICS

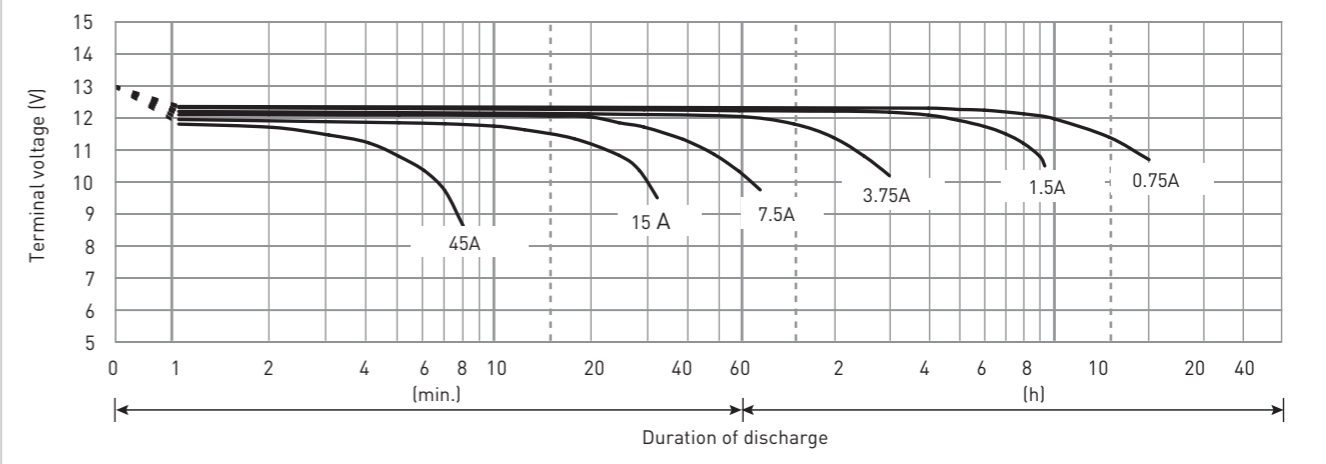

The data in this document are for descriptive purposes only and are not intended to make or imply any guarantee or warranty. Regarding handling and safety please consult our VRLA technical handbook chapter 1.